

ASIMETO

Empowering Possibilities

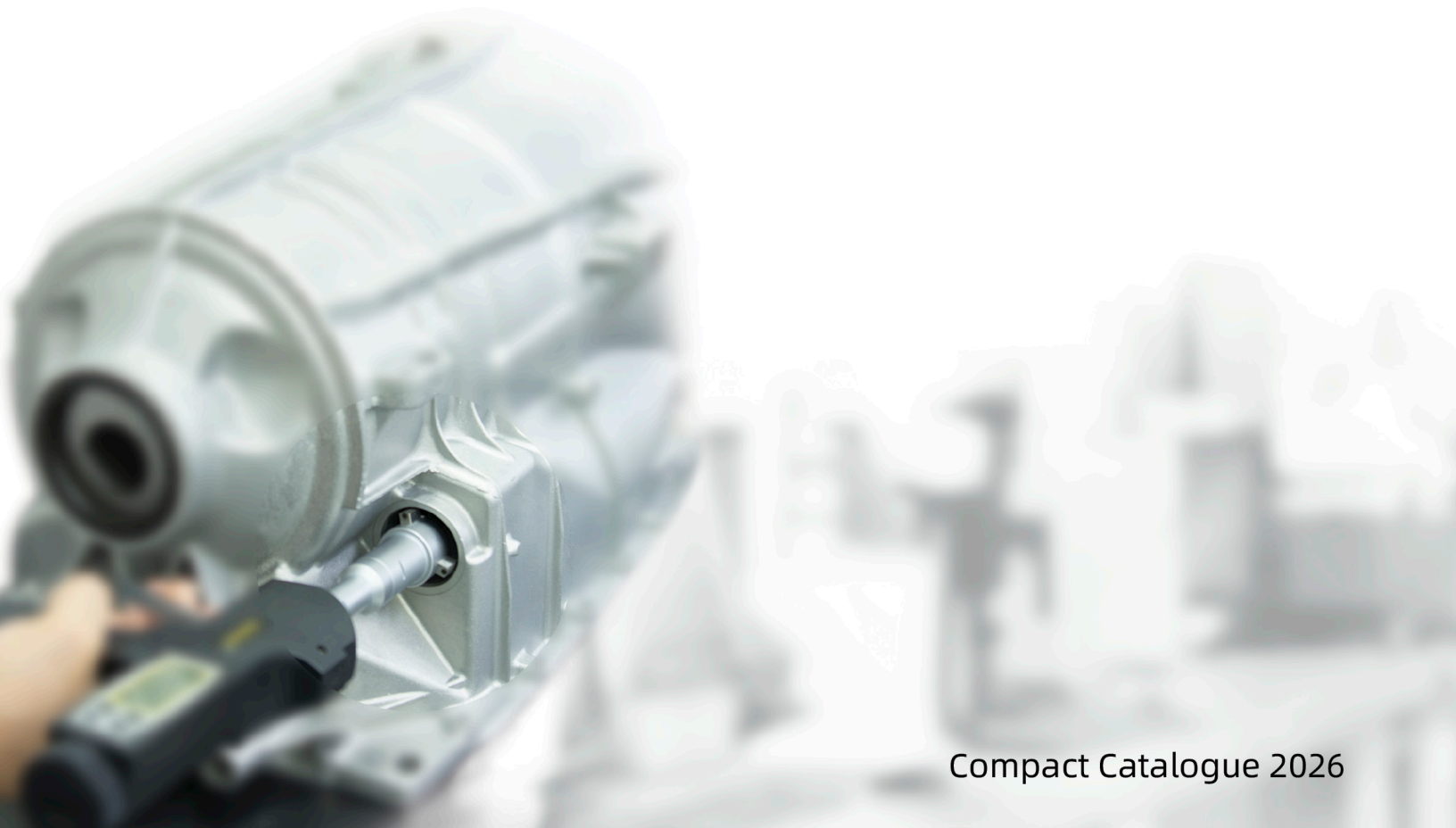

Compact Catalogue 2026

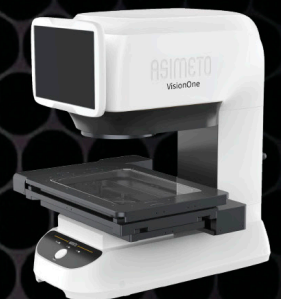
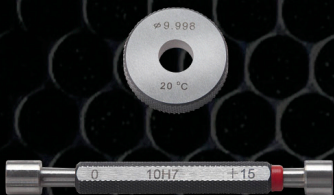

3 Micrometers



14 Calipers



21 Depth & Height Gauges

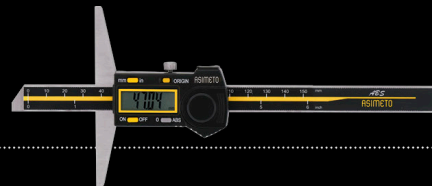

27 Indicators



33 Gauges



39 Testers & Optical Instrument



42 Asimeto Data Output



Precision is not only defined by degrees of exactness. It is defined by the vision and skill of engineers. By problems solved, challenges overcome and reputations made. The real value of precision is the power it gives engineers to turn plans into reality.

ASIMETO - Empowering Possibilities.

Asimeto was founded in 2004 by renowned German metrologist Manfred Eisinger. Since then, the company has rapidly established a reputation for manufacturing high-performance precision tools and solutions and delivering them at unexpectedly affordable prices.

Asimeto continues to win market share by applying German metrological design, American technological innovation and Asian manufacturing competitiveness across a broad range of integrated precision solutions, distributed through a global network. Every tool is ISO17025 certified for dependable accuracy and to ensure calibration is compliant with the regulatory requirements of each local market. Increasingly, Asimeto is the choice of engineers the world over including companies like Volkswagen, Guhring and Boeing. We invite you to discover more.

ASIMETO

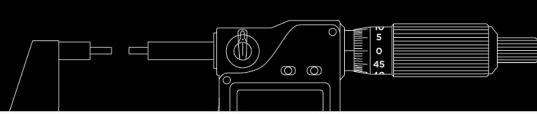

IP65 Speedymike Digital Micrometers

106 Series



106-01-2

FEATURES

- Resolution: .00005"/0.001mm
- With 2mm feed per revolution
- Built in wireless transmission
- Button function: On/Off, ABS, mm/ inch, Zero, Data transfer
- Carbide tipped measuring faces
- Actual absolute measuring position will be displayed when turn on the tools
- Auto-Off to maximize battery life
- Setting standards are included (except 0-25mm/0-1")
- Protection level IP65



Inch		Metric		Dimensions		
Range	Accuracy	Range	Accuracy	L	A	Code No.
0-1"	±.00010"	0-25mm	±0.002mm	30mm	24.5mm	106-01-2
1-2"	±.00010"	25-50mm	±0.002mm	55mm	31mm	106-02-2
2-3"	±.00010"	50-75mm	±0.003mm	81mm	44mm	106-03-2
3-4"	±.00015"	75-100mm	±0.003mm	106mm	56mm	106-04-2

IP65 Speedymike Digital Micrometers

106 Series



106-01-0

FEATURES

- Resolution: .00005"/0.001mm
- With 2mm feed per revolution
- Button function: On/Off, ABS, mm/ inch, Zero, Data transfer
- Carbide tipped measuring faces
- Actual absolute measuring position will be displayed when turn on the tools
- Auto-Off to maximize battery life
- Setting standards are included (except 0-25mm/0-1")
- Protection level IP65
- Optional accessory: Cable data output: 900-05-4/5



Inch		Metric		Dimensions		
Range	Accuracy	Range	Accuracy	L	A	Code No.
0-1"	±.00010"	0-25mm	±0.002mm	30mm	24.5mm	106-01-0
1-2"	±.00010"	25-50mm	±0.002mm	55mm	31mm	106-02-0
2-3"	±.00010"	50-75mm	±0.003mm	81mm	44mm	106-03-0
3-4"	±.00015"	75-100mm	±0.003mm	106mm	56mm	106-04-0

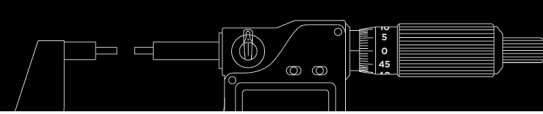

IP65 Digital Outside Micrometers

105 Series



FEATURES

- Resolution: .00005"/0.001mm
- Absolute or incremental measuring modes
- Button function: On/Off, ABS, mm/inch, Zero, Data transfer
- Carbide tipped measuring faces
- Auto-Off to maximize battery life
- Setting standards are included (except 0-25mm/0-1")
- Protection level IP65
- Optional accessory:
 - Cable data output: 900-05-4/5
 - Bluetooth data output: 901-01-2/4
 - Wireless data output:
 - Transmitting device: 901-00-4/6
 - Receiver device: 901-00-3



Inch		Metric				
Range	Accuracy	Range	Accuracy	Thimble	Inch Code No.	Metric Code No.
0-1"	±.00010"	0-25mm	±0.002mm	Dual Ratchets	105-01-5	105-01-4
1-2"	±.00010"	25-50mm	±0.002mm	Dual Ratchets	105-02-5	105-02-4
2-3"	±.00010"	50-75mm	±0.003mm	Dual Ratchets	105-03-5	105-03-4
3-4"	±.00015"	75-100mm	±0.003mm	Dual Ratchets	105-04-5	105-04-4
4-5"	±.00015"	100-125mm	±0.003mm	Dual Ratchets	105-05-5	105-05-4
5-6"	±.00015"	125-150mm	±0.003mm	Dual Ratchets	105-06-5	105-06-4
Sets						
Range	Qty.	Range	Qty.	Thimble	Inch Code No.	Metric Code No.
0-3"	3	0-75mm	3	Dual Ratchets	105-63-9	105-63-8

IP65 Digital Outside Micrometers

105 Series



FEATURES

- Resolution:
 - Digital: .00005"/0.001mm
 - Scale: .0001"/0.01mm
- Absolute or incremental measuring modes
- Button function: On/Off, Set, ABS/INC, mm/inch
- Carbide tipped measuring faces
- Auto-Off to maximize battery life
- Setting standards are included (except 0-25mm/0-1")
- Protection level IP65
- Optional accessory:
 - Cable data output: 900-10-2
 - Bluetooth data output: 901-01-5



Inch		Metric				
Range	Accuracy	Range	Accuracy	Thimble	Inch Code No.	Metric Code No.
0-1"	±.00010"	0-25mm	±0.002mm	Ratchet	105-01-1	105-01-0
1-2"	±.00010"	25-50mm	±0.002mm	Ratchet	105-02-1	105-02-0
2-3"	±.00010"	50-75mm	±0.003mm	Ratchet	105-03-1	105-03-0
3-4"	±.00015"	75-100mm	±0.003mm	Ratchet	105-04-1	105-04-0
4-5"	±.00015"	100-125mm	±0.003mm	Ratchet	105-05-1	105-05-0
5-6"	±.00015"	125-150mm	±0.003mm	Ratchet	105-06-1	105-06-0
6-7"	±.00015"	150-175mm	±0.004mm	Ratchet	105-07-1	105-07-0
7-8"	±.00015"	175-200mm	±0.004mm	Ratchet	105-08-1	105-08-0
8-9"	±.00015"	200-225mm	±0.004mm	Ratchet	105-09-1	105-09-0
9-10"	±.00020"	225-250mm	±0.004mm	Ratchet	105-10-1	105-10-0
10-11"	±.00020"	250-275mm	±0.005mm	Ratchet	105-11-1	105-11-0
11-12"	±.00020"	275-300mm	±0.005mm	Ratchet	105-12-1	105-12-0

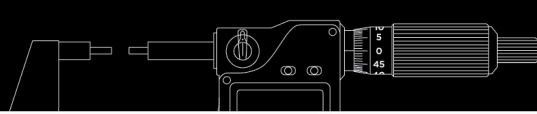

IP54 Digital Outside Micrometers

116 Series



116-01-2

FEATURES

- Resolution: .00005"/0.001mm
- Button function: On/Off, Set, ABS/INC, mm/inch, Data transfer
- Carbide tipped measuring faces
- Auto-Off to maximize battery life
- Setting standards are included (except 0-25mm/0-1")
- Protection level IP54
- Optional accessory:
 - Cable data output: 900-07-0/1
 - Bluetooth data output: 901-01-0/3
 - Wireless data output:
 - Transmitting device: 901-00-2/7
 - Receiver Device: 901-00-3



Inch		Metric		Inch Code No.	Metric Code No.
Range	Accuracy	Range	Accuracy		
0-1"	±.00010"	0-25mm	±0.002mm	116-01-3	116-01-2
1-2"	±.00010"	25-50mm	±0.002mm	116-02-3	116-02-2
2-3"	±.00010"	50-75mm	±0.003mm	116-03-3	116-03-2
3-4"	±.00015"	75-100mm	±0.003mm	116-04-3	116-04-2
4-5"	±.00015"	100-125mm	±0.003mm	116-05-3	116-05-2
5-6"	±.00015"	125-150mm	±0.003mm	116-06-3	116-06-2

Digital Outside Micrometers

116 Series



116-01-0

FEATURES

- Resolution: .00005"/0.001mm
- Ratchet friction thimble
- Button function: On/Off, Set, ABS/INC, mm/inch
- Carbide tipped measuring faces
- Auto-Off to maximize battery life
- Setting standards are included (except 0-25mm/0-1")



Inch		Metric		Inch Code No.	Metric Code No.
Range	Accuracy	Range	Accuracy		
0-1"	±.00010"	0-25mm	±0.002mm	116-01-1	116-01-0
1-2"	±.00010"	25-50mm	±0.002mm	116-02-1	116-02-0
2-3"	±.00010"	50-75mm	±0.003mm	116-03-1	116-03-0
3-4"	±.00015"	75-100mm	±0.003mm	116-04-1	116-04-0
4-5"	±.00015"	100-125mm	±0.003mm	116-05-1	116-05-0
5-6"	±.00015"	125-150mm	±0.003mm	116-06-1	116-06-0
6-7"	±.00015"	150-175mm	±0.004mm	116-07-1	116-07-0
7-8"	±.00015"	175-200mm	±0.004mm	116-08-1	116-08-0

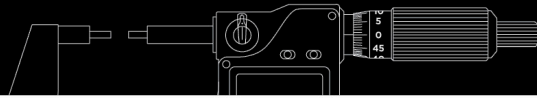

Outside Micrometers-Metric Models

101 Series

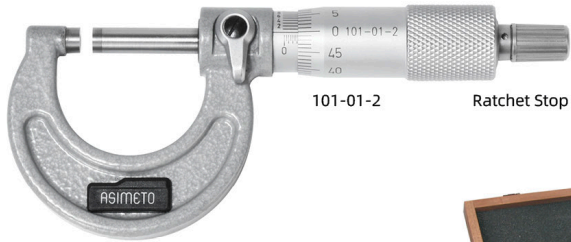

101-01-2 Ratchet Stop



101-66-8

FEATURES

- Graduation: 0.01mm/0.001mm
- Flatness: 0.6µm
- Ratchet Stop and Ratchet Thimble are optional
- Carbide tipped measuring faces
- Setting standards are included (except 0-25mm/0-1")



Ratchet Thimble

Inch			Metric				
Range	Graduation	Accuracy	Range	Graduation	Accuracy	Inch Code No.	Metric Code No.
0-1"	.001"	±.0001"	0-25mm	0.01mm	0.004mm	101-01-1	101-01-0
1-2"	.001"	±.0002"	25-50mm	0.01mm	0.004mm	101-02-1	101-02-0
-	-	-	50-75mm	0.01mm	0.005mm	-	101-03-0
-	-	-	75-100mm	0.01mm	0.005mm	-	101-04-0
-	-	-	100-125mm	0.01mm	0.006mm	-	101-05-0
-	-	-	125-150mm	0.01mm	0.006mm	-	101-06-0
-	-	-	150-175mm	0.01mm	0.007mm	-	101-07-0
-	-	-	175-200mm	0.01mm	0.007mm	-	101-08-0
-	-	-	200-225mm	0.01mm	0.008mm	-	101-09-0
-	-	-	225-250mm	0.01mm	0.008mm	-	101-10-0
-	-	-	250-275mm	0.01mm	0.009mm	-	101-11-0
-	-	-	275-300mm	0.01mm	0.009mm	-	101-12-0
0-1"	.0001"	±.0001"	0-25mm	0.001mm	0.004mm	101-01-3	101-01-2
1-2"	.0001"	±.0002"	25-50mm	0.001mm	0.004mm	101-02-3	101-02-2
2-3"	.0001"	±.0002"	50-75mm	0.001mm	0.005mm	101-03-3	101-03-2
3-4"	.0001"	±.0002"	75-100mm	0.001mm	0.005mm	101-04-3	101-04-2
4-5"	.0001"	±.0002"	100-125mm	0.001mm	0.006mm	101-05-3	101-05-2
5-6"	.0001"	±.0002"	125-150mm	0.001mm	0.006mm	101-06-3	101-06-2
-	-	-	150-175mm	0.001mm	0.007mm	-	101-07-2
-	-	-	175-200mm	0.001mm	0.007mm	-	101-08-2
8-9"	.0001"	±.0002"	200-225mm	0.001mm	0.008mm	101-09-3	101-09-2
-	-	-	225-250mm	0.001mm	0.008mm	-	101-10-2
-	-	-	250-275mm	0.001mm	0.009mm	-	101-11-2
-	-	-	275-300mm	0.001mm	0.009mm	-	101-12-2

Inch		Metric			
Range	Graduation	Range	Graduation	Inch Code No.	Metric Code No.
-	-	0-100mm	0.01mm	-	101-64-8
-	-	0-150mm	0.01mm	-	101-66-8
0-6"	.0001"	0-150mm	0.001mm	101-66-7	101-66-6

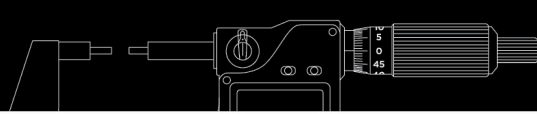

Interchangeable Anvil Outside Micrometers

111/115 Series



111-16-0

FEATURES

- Graduation: .001"/0.01mm
- Flatness: .00004"/1µm
- Ratchet stop
- Interchangeable anvils provide wider measuring ranges
- Carbide tipped measuring faces
- Grey painted steel frame for models up to 12"/300mm
- Grey welded pipe frame for models over 12"/300mm

Note:
Individual anvils are matched as a set with the frame.
If using different frame, accuracy may be affected.

Inch		Metric		Digital Models		Mechanical Models			
Range	Accuracy	Range	Accuracy	Anvils	Standards	Inch Code No.	Metric Code No.	Inch Code No.	Metric Code No.
0-6"	±.0002"	0-150mm	0.006mm	6 pcs	5 pcs	115-06-1	115-06-0	111-06-1	111-06-0
6-12"	±.0003"	150-300mm	0.008mm	6 pcs	6 pcs	115-12-1	115-12-0	111-12-1	111-12-0
12-16"	±.0004"	300-400mm	0.011mm	4 pcs	2 pcs	115-16-1	115-16-0	111-16-1	111-16-0
-	-	400-500mm	0.013mm	4 pcs	2 pcs	-	115-20-0	-	111-20-0
20-24"	±.0006"	500-600mm	0.015mm	4 pcs	2 pcs	115-24-1	-	-	111-24-0
24-28"	±.0006"	600-700mm	0.016mm	4 pcs	2 pcs	115-28-1	115-28-0	-	111-28-0

Digital Inside Micrometers

207 Series



207-01-0

FEATURES

- Resolution: .00005"/0.001mm
- Designed for the measurement of intricate internal characteristics
- Solid carbide pins for measurement contact points
- Satin chrome finished
- .2-1.2"/5-30mm and 1-2"/25-50mm range are supplied with setting ring
- Button function: On/Off, Set,
- ABS/INC, mm/inch
- Carbide tipped measuring faces
- Auto-Off to maximize battery life
- Optional accessory:
Cable data output: 900-10-2
Bluetooth data output: 901-01-5



Inch		Metric		Inch		Metric	
Range	Resolution	Accuracy	Range	Resolution	Accuracy	Inch Code No.	Metric Code No.
.2-1.2"	.00005"	±.0001"	5-30mm	0.001mm	±0.003mm	207-01-1	207-01-0
-	-	-	25-50mm	0.001mm	±0.003mm	-	207-02-0

Inside Micrometers

203 Series



203-02-0

FEATURES

- Graduation: .001"/0.01mm
- Designed for the measurement of intricate internal characteristics
- .2-1.2"/5-30mm and 1-2"/25-50mm range are supplied with setting ring

Inch		Metric		Inch		Metric	
Range	Graduation	Accuracy	Range	Graduation	Accuracy	Inch Code No.	Metric Code No.
.2-1.2"	.001"	±.0001"	5-30mm	0.01mm	0.005mm	203-01-1	203-01-0
1-2"	.001"	±.0002"	25-50mm	0.01mm	0.006mm	203-02-1	203-02-0
-	-	-	50-75mm	0.01mm	0.007mm	-	203-03-0
-	-	-	75-100mm	0.01mm	0.008mm	-	203-04-0

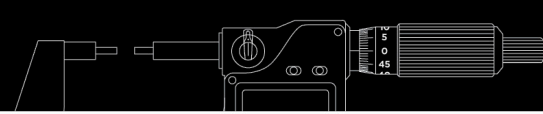

Point Micrometers

126 Series



126-01-0

FEATURES

- Resolution:
Digital reading: .00005"/0.001mm
- 15 degree and 30 degree measuring points are available
- For web thickness of drills, small grooves, and other hard to reach dimensions, etc. measurements
- Button function: On/Off, Set, ABS/INC, mm/inch
- Carbide tipped measuring faces
- Actual absolute measuring position will be displayed when turn on the tools
- Auto-Off to maximize battery life
- Setting standards are included (except 0-25mm/0-1")
- Protection level IP65
- Optional accessory:
Cable data output: 900-10-2
Bluetooth data output: 901-01-5



Inch		Metric		Anvil Type	Inch Code No.	Metric Code No.
Range	Resolution	Range	Resolution			
0-1"	±.0001"	0-25mm	±0.002mm	15°	126-01-1	126-01-0
-	-	0-25mm	±0.002mm	30°	-	126-01-2

Disc Micrometers

145 Series



145-01-1

FEATURES

- Resolution:
Digital reading: .00005"/0.001mm
- For gears and paper thickness measurements
- Non-rotating spindle
- Button function: On/Off, Set, ABS/INC, mm/inch
- Carbide tipped measuring faces
- Actual absolute measuring position will be displayed when turn on the tools
- Auto-Off to maximize battery life
- Setting standards are included (except 0-25mm/0-1")
- Protection level IP65
- Optional accessory:
Cable data output: 900-10-2
Bluetooth data output: 901-01-5

Inch		Metric		Inch Code No.	Metric Code No.
Range	Accuracy	Range	Accuracy		
0-1"	±.0001"	-	-	145-01-1	-

Disc Micrometers

141 Series



141-02-3

FEATURES

- Graduation: .0001"/0.01mm
- For gears and paper thickness measurements
- Rotating spindle and non-rotating spindle (optional)
- Setting standards are included (except 0-25mm/0-1")

Inch		Metric		Inch Code No.	Metric Code No.
Range	Accuracy	Range	Accuracy		
1-2"	±.0002"	25-50mm	0.004mm	141-02-3	141-02-2
-	-	50-75mm	0.005mm	-	141-03-2

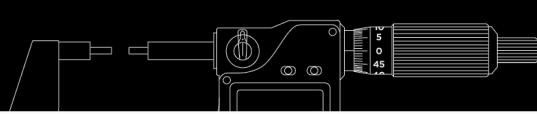

Tube Micrometers

147 Series



147-01-0

FEATURES

- Resolution: Digital reading: .00005"/0.001mm
- For various tubes wall thickness measurement
- Anvils J and Anvils K are optional
- Button function: On/Off, Set, ABS/INC, mm/inch
- Carbide tipped measuring faces
- Actual absolute measuring position will be displayed when turn on the tools
- Auto-Off to maximize battery life
- Setting standards are included (except 0-25mm/0-1")
- Protection level IP65
- Optional accessory: Cable data output: 900-10-2 Bluetooth data output: 901-01-5



Inch		Anvil Type J		Anvil Type K		Metric		Anvil Type J		Anvil Type K	
Range	Accuracy	Code No.	Code No.	Range	Accuracy	Code No.	Code No.	Code No.	Code No.	Code No.	Code No.
0-1"	±.0001"	147-01-1	147-01-3	0-25mm	±0.002mm	147-01-0	147-01-2				
1-2"	±.0002"	147-02-1	147-02-3	25-50mm	±0.002mm	147-02-0	147-02-2				
2-3"	±.0002"	147-03-1	147-03-3	50-75mm	±0.003mm	147-03-0	147-03-2				
3-4"	±.0002"	147-04-1	147-04-3	75-100mm	±0.003mm	147-04-0	147-04-2				

Tube Micrometers

143 Series



143-01-3

FEATURES

- Graduation: .0001"/0.01mm
- For various tubes wall thickness measurement
- Carbide tipped measuring faces
- Setting standards are included (except 0-25mm/0-1")

Inch		Metric			
Range	Accuracy	Range	Accuracy	Inch Code No.	Metric Code No.
0-1"	±.0001"	0-25mm	0.004mm	143-01-1	143-01-0

Blade Micrometers

117 Series



117-01-0

FEATURES

- Resolution: Digital reading: .00005"/0.001mm
- For measuring the groove diameter of shafts, keyways, and other hard to reach portions
- Non-rotating spindle
- Button function: On/Off, Set, ABS/INC, mm/inch
- Carbide tipped measuring faces
- Actual absolute measuring position will be displayed when turn on the tools
- Auto-Off to maximize battery life
- Setting standards are included (except 0-25mm/0-1")
- Optional accessory: Cable data output: 900-10-2 Bluetooth data output: 901-01-5



Range	Accuracy	Code No.
0-25mm	±0.002mm	117-01-0
25-50mm	±0.002mm	117-02-0

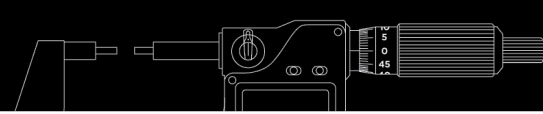

Micrometer Stands

109 Series



Code No.: 109-01-0
Painted Steel Base



Code No.: 109-02-1
Painted Cast-Iron Base

FEATURES

- These stands are designed to allow bench top use with hand micrometers

Digital Two And Three Point Internal Micrometers (2-12mm/.08-.5")

208/209 Series



208-12-0

FEATURES

- Resolution: .00005"/0.001mm
- Protection level IP65
- Setting ring supplied
- Measuring contact points are designed to allow measurements near to the bottom of blind holes
- Size up to 6mm/.24 inch are two measuring points; size over 6mm/.24 inch are three measuring points
- Button function: On/Off, Set, ABS/INC, mm/inch
- Measuring surfaces are carbide
- Auto-Off to maximize battery life
- Optional accessory: Cable data output: 900-10-2 Bluetooth data output: 901-01-5



Inch			Metric					
Range	Accuracy	Setting Ring	Range	Accuracy	Setting Ring	Extension Rod	Inch Code No.	Metric Code No.
Digital Models								
.275-.35"	±.0001"	.275"	6-8mm	0.004mm	6mm	100mm	208-11-1	208-11-0
.35-.425"	±.0001"	.35"	8-10mm	0.004mm	8mm	100mm	208-12-1	208-12-0
.425-.5"	±.0001"	.5"	10-12mm	0.004mm	10mm	100mm	208-13-1	208-13-0
Mechanical Models								
.275-.35"	±.0001"	.275"	6-8mm	0.004mm	6mm	100mm	209-11-1	209-11-0
.35-.425"	±.0001"	.35"	8-10mm	0.004mm	8mm	100mm	209-12-1	209-12-0
.425-.5"	±.0001"	.5"	10-12mm	0.004mm	10mm	100mm	209-13-1	209-13-0

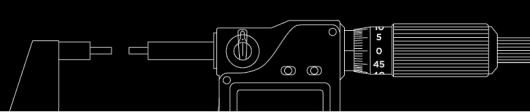

Digital Three Point Internal Micrometers (12-100mm/.5-4.0")

208/209 Series



208-28-0

FEATURES

- Resolution: .00005"/0.001mm
- Setting ring supplied
- Measuring contact points are designed to allow measurements near to the bottom of blind holes
- Additional extensions can be added to increase the measuring depth
- Button function: On/Off, Set, ABS/INC, mm/inch
- Measuring surfaces are carbide
- Auto-Off to maximize battery life
- Protection level IP65
- Optional accessory: Cable data output: 900-10-2 Bluetooth data output: 901-01-5



Inch			Metric					
Range	Accuracy	Setting Ring	Range	Accuracy	Setting Ring	Extension Rod	Inch Code No.	Metric Code No.
Digital Models								
.5-.65"	±.0001"	.65"	12-16mm	0.004mm	16mm	150mm	208-24-1	208-24-0
.65-.8"	±.0001"	.65"	16-20mm	0.004mm	16mm	150mm	208-25-1	208-25-0
.8-1"	±.0001"	1"	20-25mm	0.004mm	25mm	150mm	208-26-1	208-26-0
1-1.2"	±.0002"	1"	25-30mm	0.004mm	25mm	150mm	208-27-1	208-27-0
1.2-1.6"	±.0002"	1.6"	30-40mm	0.004mm	40mm	150mm	208-28-1	208-28-0
1.6-2"	±.0002"	1.6"	40-50mm	0.005mm	40mm	150mm	208-29-1	208-29-0
2-2.5"	±.0002"	2.5"	50-63mm	0.005mm	62mm	150mm	208-30-1	208-30-0
2.5-3"	±.0002"	2.5"	62-75mm	0.005mm	62mm	150mm	208-31-1	208-31-0
3-3.5"	±.0002"	3.5"	75-88mm	0.005mm	87mm	150mm	208-32-1	208-32-0
3.5-4"	±.0002"	3.5"	87-100mm	0.005mm	87mm	150mm	208-33-1	208-33-0
Mechanical Models								
-	-	-	12-16mm	0.004mm	16mm	150mm	-	209-24-0
-	-	-	16-20mm	0.004mm	16mm	150mm	-	209-25-0
-	-	-	20-25mm	0.004mm	25mm	150mm	-	209-26-0
-	-	-	25-30mm	0.004mm	25mm	150mm	-	209-27-0
-	-	-	30-40mm	0.004mm	40mm	150mm	-	209-28-0
-	-	-	40-50mm	0.005mm	40mm	150mm	-	209-29-0
-	-	-	50-63mm	0.005mm	62mm	150mm	-	209-30-0
-	-	-	62-75mm	0.005mm	62mm	150mm	-	209-31-0
-	-	-	75-88mm	0.005mm	87mm	150mm	-	209-32-0
-	-	-	87-100mm	0.005mm	87mm	150mm	-	209-33-0

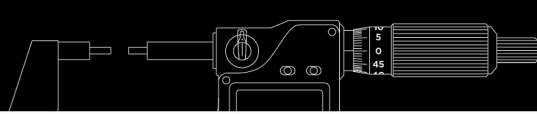

Grip Three Point Internal Micrometers

210 Series



210-26-0

FEATURES

- Resolution: .00005"/0.001mm
- Built in wireless data transmission
- Tolerance preset and GO/NG judgement
- Multi-Angle Viewing: 330° rotating screen ensures easy-to-read measurements
- Measuring contact points are designed to allow measurements near the bottom of blind holes
- Measuring surface are carbide (12mm above)
- Additional extensions can be added to increase the measuring depth
- Setting rings for origin point setting
- Setting ring is not included for size 100mm / 4" or above



				Metric
Range	Accuracy	Setting Ring	Extension Rod	Code No.
6-8mm	0.004mm	8mm	100mm	210-11-0
8-10mm	0.004mm	8mm	100mm	210-12-0
10-12mm	0.004mm	12mm	100mm	210-13-0
12-16mm	0.004mm	16mm	150mm	210-24-0
16-20mm	0.004mm	16mm	150mm	210-25-0
20-25mm	0.004mm	25mm	150mm	210-26-0
25-30mm	0.004mm	25mm	150mm	210-27-0
30-40mm	0.004mm	40mm	150mm	210-28-0
40-50mm	0.004mm	40mm	150mm	210-29-0
50-63mm	0.005mm	62mm	150mm	210-30-0
62-75mm	0.005mm	62mm	150mm	210-31-0
75-88mm	0.005mm	87mm	150mm	210-32-0
87-100mm	0.005mm	87mm	150mm	210-33-0

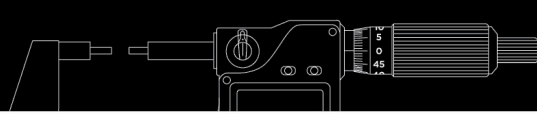

Digital Pistol-Grip Three Point Internal Micrometers

211 Series



211-33-0

FEATURES

- Resolution: .00005"/0.001mm
- Absolute capacitive system
- Built in wireless data transmission
- Measuring contact points are designed to allow measurements near the bottom of blind holes
- Measuring surface are carbide (12mm above)
- Display can rotate 90°
- Setting ring is not included for size 100mm / 4" or above



Range	Accuracy	Setting Ring	Dimensions		Extension Rod	Metric
			L	A		Code No.
6-8mm	0.004mm	8mm	55mm	1.0mm	100mm	211-11-0
8-10mm	0.004mm	8mm	55mm	1.5mm	100mm	211-12-0
10-12mm	0.004mm	12mm	55mm	1.5mm	100mm	211-13-0
12-16mm	0.004mm	16mm	80mm	0.5mm	150mm	211-24-0
16-20mm	0.004mm	16mm	80mm	0.5mm	150mm	211-25-0
20-25mm	0.004mm	25mm	90mm	0.5mm	150mm	211-26-0
25-30mm	0.004mm	25mm	90mm	0.5mm	150mm	211-27-0
30-40mm	0.004mm	40mm	105mm	0.5mm	150mm	211-28-0
40-50mm	0.004mm	40mm	105mm	0.5mm	150mm	211-29-0
50-63mm	0.005mm	62mm	127mm	0.5mm	150mm	211-30-0
62-75mm	0.005mm	62mm	127mm	0.5mm	150mm	211-31-0
75-88mm	0.005mm	87mm	127mm	0.5mm	150mm	211-32-0
87-100mm	0.005mm	87mm	127mm	0.5mm	150mm	211-33-0

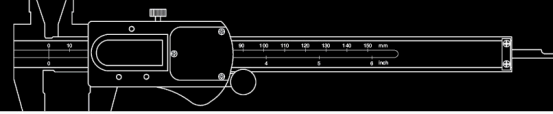

IP67 Digital Calipers - SYLVAC SYSTEM

301 Series

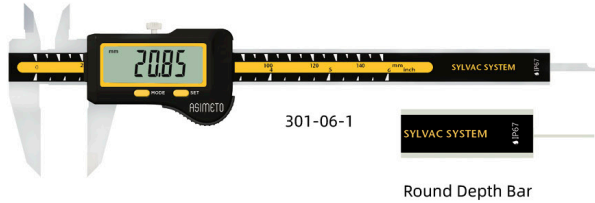

301-06-1

Round Depth Bar

FEATURES

- Resolution: .0005"/0.01mm
- Button function: On/Off, Zero, mm/ inch, Preset
- Auto-Off
- Sylvac system
- Protection level IP67



Inch		Metric		Remark	Code No.
Range	Accuracy	Range	Accuracy		
0-6"	±.001"	0-150mm	±0.02mm		301-06-1
0-6"	±.001"	0-150mm	±0.02mm	Round Depth Bar Ø1.5mm	301-06-3
0-8"	±.0015"	0-200mm	±0.03mm		301-08-1
0-12"	±.0015"	0-300mm	±0.03mm		301-12-1

IP67 Digital Caliper

301 Series



301-06-8

FEATURES

- Resolution: .0005"/0.01mm
- Buttons: On/Off, inch/mm, Zero, Preset
- Auto-On/Off. Move the scale can turn on the caliper again
- Built in bluetooth transmission Built-in rechargeable lithium battery, magnetic charging port, convenient and fast
- Protection level IP67



Inch		Metric		Data Output Type	Dimensions					With Thumb Wheel	Without Thumb Wheel
Range	Accuracy	Range	Accuracy		L	a	b	c	d	Code No.	Code No.
0-6"	±.001"	0-150mm	±0.02mm	Bluetooth	235mm	40mm	20mm	15.5mm	16mm	301-06-8	301-06-9
0-8"	±.0015"	0-200mm	±0.03mm	Bluetooth	287mm	50mm	24mm	19.5mm	16mm	301-08-8	301-08-9
0-12"	±.0015"	0-300mm	±0.03mm	Bluetooth	390mm	60mm	26mm	21.5mm	16mm	301-12-8	301-12-9

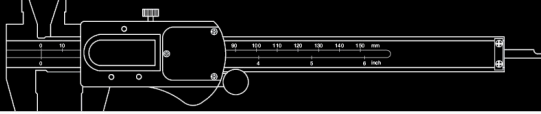

IP67 Digital Pointer Type Calipers

305 Series

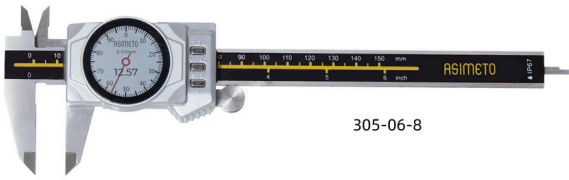

305-06-8

FEATURES

- Resolution: .0005"/0.01mm
- Color display. Digital dial face and number display at the same time
- Button function: On/Off, Zero, mm/ inch, Night, INC, Hold, Tol, Data
- Tolerance set and GO/NG indication
- Auto-Off
- Built-in bluetooth data transmission
- Magnetic charging
- Protection level IP67



Inch		Metric		Dimensions						With Thumb Wheel	Without Thumb Wheel
Range	Accuracy	Range	Accuracy	Data Output Type	L	a	b	c	d	Code No.	Code No.
0-4"	±.001"	0-100mm	±0.02mm	Bluetooth	185mm	40mm	20mm	15.5mm	16mm	305-04-8	305-04-9
0-6"	±.001"	0-150mm	±0.02mm	Bluetooth	235mm	40mm	20mm	15.5mm	16mm	305-06-8	305-06-9
0-8"	±.0015"	0-200mm	±0.03mm	Bluetooth	287mm	50mm	24mm	19.5mm	16mm	305-08-8	305-08-9
0-12"	±.0015"	0-300mm	±0.03mm	Bluetooth	390mm	60mm	26mm	21.5mm	16mm	305-12-8	305-12-9

IP67 Digital Calipers

305 Series

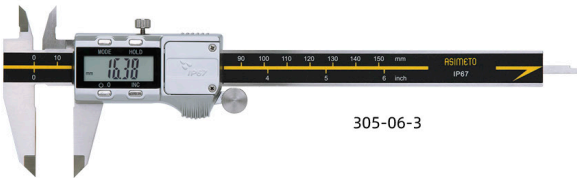

305-06-3

FEATURES

- Resolution: .0005"/0.01mm
- Metal housing, strong and durable
- Hold function for easy reading
- Button function: On/Off, Zero, mm/inch, ABS/INC, Hold
- Auto-On/Off
- Protection level IP67



Inch		Metric		Dimensions						With Thumb Wheel	Without Thumb Wheel
Range	Accuracy	Range	Accuracy	L	a	b	c	d	Code No.	Code No.	
0-6"	±.001"	0-150mm	±0.02mm	236mm	40mm	21mm	16.5mm	16mm	305-06-3	305-06-4	
0-8"	±.0015"	0-200mm	±0.03mm	286mm	50mm	24mm	19.5mm	16mm	305-08-3	305-08-4	
0-12"	±.0015"	0-300mm	±0.03mm	400mm	60mm	25mm	20.5mm	16mm	305-12-3	305-12-4	

IP67 Big Screen Digital Calipers

305 Series

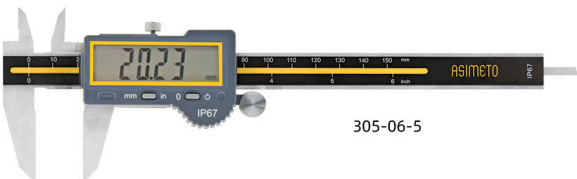

305-06-5

FEATURES

- Resolution: .0005"/0.01mm
- Large screen: (53.5 x 15.5mm) LCD display area
- Button function: On/Off, Zero, mm/inch
- Auto-Off
- Memory function: keep the reading when display off
- Protection level IP67



Inch		Metric		With Thumb Wheel	Without Thumb Wheel
Range	Accuracy	Range	Accuracy	Code No.	Code No.
0-6"	±.001"	0-150mm	±0.02mm	305-06-5	305-06-6
0-8"	±.0015"	0-200mm	±0.03mm	305-08-5	305-08-6
0-12"	±.0015"	0-300mm	±0.03mm	305-12-5	305-12-6

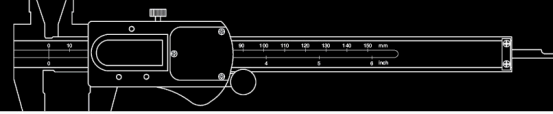

Big Screen Digital Calipers

306 Series

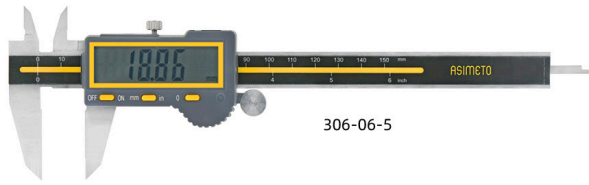

FEATURES

- Resolution: .0005"/0.01mm
- Large screen: (53.5 x 15.5mm) LCD display area
- Button function: On/Off, Zero, mm/inch
- Auto-Off
- Optional accessory: Cable data output: 900-06-0/1



Inch		Metric		With Thumb Wheel	Without Thumb Wheel
Range	Accuracy	Range	Accuracy	Code No.	Code No.
0-6"	±.001"	0-150mm	±0.02mm	306-06-5	306-06-6
0-8"	±.0015"	0-200mm	±0.03mm	306-08-5	306-08-6
0-12"	±.0015"	0-300mm	±0.03mm	306-12-5	306-12-6

Digital Calipers (Four Buttons)

307 Series

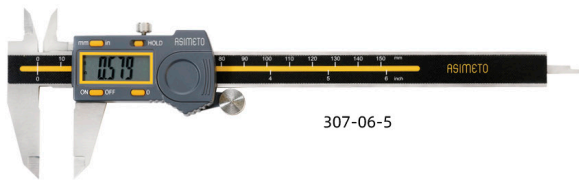

FEATURES

- Resolution: .0005"/0.01mm
- Button function: On/Off, Hold, mm/inch, Zero
- Auto-Off
- Optional accessory: Cable data output: 900-06-0/1



Inch		Metric		With Thumb Wheel	Without Thumb Wheel
Range	Accuracy	Range	Accuracy	Code No.	Code No.
0-4"	±.001"	0-100mm	±0.02mm	307-04-5	307-04-4
0-6"	±.001"	0-150mm	±0.02mm	307-06-5	307-06-4
0-8"	±.0015"	0-200mm	±0.03mm	307-08-5	307-08-4
0-12"	±.0015"	0-300mm	±0.03mm	307-12-5	307-12-4

Digital Calipers (Three Buttons)

307 Series



FEATURES

- Resolution: .0005"/0.01mm
- Button function: On/Off, mm/inch, Zero
- Auto-Off



Inch		Metric		With Thumb Wheel	Without Thumb Wheel
Range	Accuracy	Range	Accuracy	Code No.	Code No.
0-6"	±.001"	0-150mm	±0.02mm	307-26-1	307-26-0
0-8"	±.0015"	0-200mm	±0.03mm	307-28-1	307-28-0
0-12"	±.0015"	0-300mm	±0.03mm	307-32-1	307-32-0

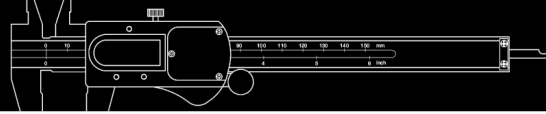

Absolute Digital Calipers

307 Series

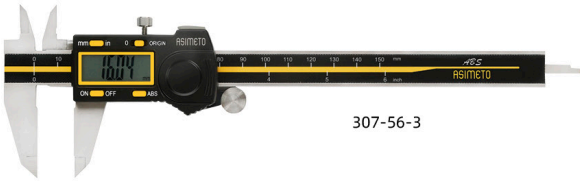

307-56-3

FEATURES

- Resolution: .0005"/0.01mm
- Button function: On/Off, ABS/0, mm/inch, Origin
- Absolute system delivers reliable measurement
- Auto-Off
- Optional accessory:
 - Cable data output: 900-05-4/5
 - Bluetooth data output: 901-01-2/4
 - Wireless data output:
 - Transmitting device: 901-00-4/6
 - Receiver device: 901-00-3



Inch		Metric		With Thumb Wheel	Without Thumb Wheel
Range	Accuracy	Range	Accuracy	Code No.	Code No.
0-6"	±.001"	0-150mm	±0.02mm	307-56-3	307-56-2
0-8"	±.0015"	0-200mm	±0.03mm	307-58-3	307-58-2
0-12"	±.0015"	0-300mm	±0.03mm	307-62-3	307-62-2

Multi-function Digital Calipers

318 Series



318-06-3

FEATURES

- Resolution: .0005"/0.01mm
- With preset value function, the initial value can be set arbitrarily
- Button function: ABS/0, mm/inch, Origin, Preset
- Absolute system delivers reliable measurement
- Auto-Off
- Optional accessory:
 - Cable data output: 900-05-4/5
 - Bluetooth data output: 901-01-2/4
 - Wireless data output:
 - Transmitting device: 901-00-4/6
 - Receiver device: 901-00-3



Inch		Metric		With Thumb Wheel	Without Thumb Wheel
Range	Accuracy	Range	Accuracy	Code No.	Code No.
0-6"	±.001"	0-150mm	±0.03mm	318-06-3	318-06-2
0-8"	±.0015"	0-200mm	±0.03mm	318-08-3	318-08-2
0-12"	±.002"	0-300mm	±0.04mm	318-12-3	318-12-2

Universal Digital Calipers With Exchangeable Measuring Points

317 Series

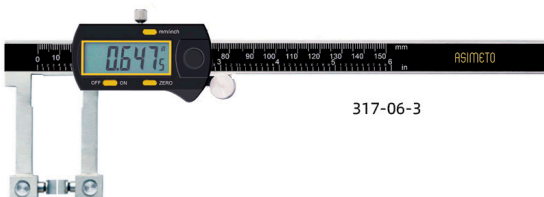

317-06-3

FEATURES

- Resolution: .0005"/0.01mm
- Various exchangeable measuring tips for option
- Used for ID, OD and Thickness measurements
- Button function: On/Off, mm/inch, Zero
- Auto-Off



Inch		Metric		Code No.
Range	Accuracy	Range	Accuracy	Code No.
0-6"	±.003"	0-150mm	±0.04mm	317-06-3
0-8"	±.003"	0-200mm	±0.04mm	317-08-3
0-12"	±.004"	0-300mm	±0.05mm	317-12-3

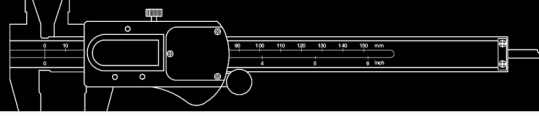

IP65 Carbon Fiber Digital Calipers

316 Series

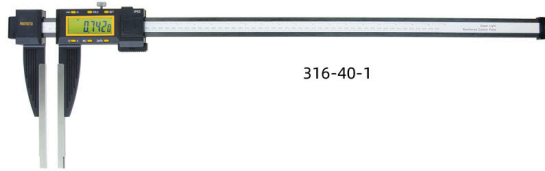

316-40-1

FEATURES

- Resolution: .0005"/0.01mm
- SPC data output
- Built in wireless transmission
- Round measuring faces
- Button function: On/Off, INC, Zero, mm/inch, Hold, Set, Data transfer
- Auto-Off
- Main frame is made of carbon fiber
- Protection level IP65



Inch			Metric				
Range	Resolution	Accuracy	Range	Resolution	Accuracy	Jaw Length (A)	Code No.
0-40"	.0005"	±.0025"	0-1000mm	0.01mm	0.06mm	138mm	316-40-1
0-40"	.0005"	±.004"	0-1000mm	0.01mm	0.10mm	200mm	316-40-2
0-40"	.0005"	±.0055"	0-1000mm	0.01mm	0.13mm	300mm	316-40-3
0-40"	.0005"	±.008"	0-1000mm	0.01mm	0.20mm	500mm	316-40-4
0-60"	.0005"	±.0055"	0-1500mm	0.01mm	0.13mm	200mm	316-60-2
0-60"	.0005"	±.007"	0-1500mm	0.01mm	0.17mm	300mm	316-60-3
0-60"	.0005"	±.012"	0-1500mm	0.01mm	0.30mm	500mm	316-60-4
0-80"	.0005"	±.007"	0-2000mm	0.01mm	0.17mm	200mm	316-80-2
0-80"	.0005"	±.008"	0-2000mm	0.01mm	0.20mm	300mm	316-80-3
0-80"	.0005"	±.014"	0-2000mm	0.01mm	0.35mm	500mm	316-80-4

ABS Heavy Duty Digital Calipers

315 Series

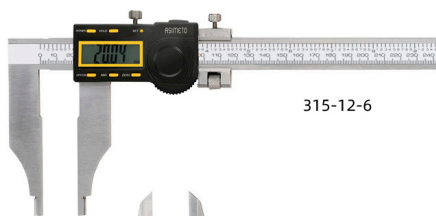

315-12-6

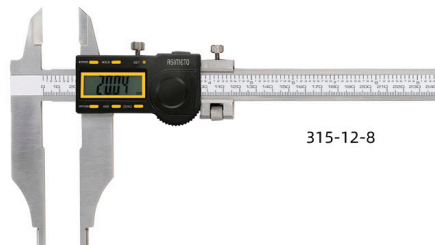

315-12-8

FEATURES

- Resolution: .0005"/0.01mm
- Internal measurement jaws are rounded to provide accurate measurement of internal diameters
- Absolute delivery reliable measurement
- Button function: On/Off, ABS, Zero, mm/inch, Hold, Preset
- Auto-Off
- With or without upper jaws models are available
- Optional accessory:
 - Cable data output: 900-05-4/5
 - Bluetooth data output: 901-01-2/4
 - Wireless data output:
 - Transmitting device: 901-00-4/6
 - Receiver device: 901-00-3



Inch			Metric			Without Upper Jaws		With Upper Jaws
Range	Resolution	Accuracy	Range	Resolution	Accuracy	Jaw Length	Code No.	Code No.
0-12"	.0005"	±.0015"	0-300mm	0.01mm	±0.04mm	90mm	315-12-6	315-12-8
0-20"	.0005"	±.002"	0-500mm	0.01mm	±0.05mm	150mm	315-20-6	315-20-8
0-24"	.0005"	±.002"	0-600mm	0.01mm	±0.05mm	100mm	315-24-6	-

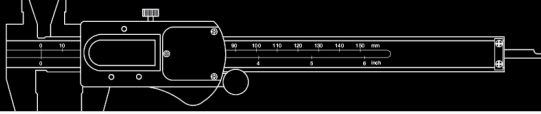

Vernier Calipers - Plain

341/351 Series

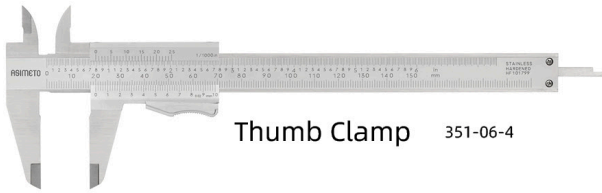
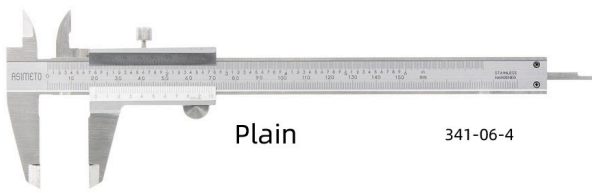

FEATURES

- Graduation:
Inch: .001" or 1/128"
Metric: 0.02mm or 0.05mm
- Various models available with an assortment of dual scales
- Measuring surfaces allow for the measurement of external diameters, internal diameters, depths and steps
- The upper and lower scales on the slider are angled to reduce parallax error
- Stainless steel with surface hardened measuring faces
- Models are available with the slider operation in either plain, thumb clamp, fine adjustment Inch

Mono Block Models

Range		Graduation		Accuracy	Note	Code No.
Lower	Upper	Lower	Upper			
Plain						
0-150mm	0-6"	0.05mm	1/128"	±0.05mm	Upper Lock	341-06-0
0-200mm	0-8"	0.05mm	1/128"	±0.05mm	Upper Lock	341-08-0
0-150mm	0-6"	0.02mm	.001"	±0.03mm	Upper Lock	341-06-4
0-200mm	0-8"	0.02mm	.001"	±0.03mm	Upper Lock	341-08-4
0-300mm	0-12"	0.02mm	.001"	±0.04mm	Upper Lock	341-12-4
Thumb Clamp						
0-200mm	0-8"	0.05mm	1/128"	±0.05mm	-	351-08-0
0-150mm	0-6"	0.02mm	0.001"	±0.03mm	-	351-06-4

Long Jaw Vernier Calipers (Mono Block)

311 Series

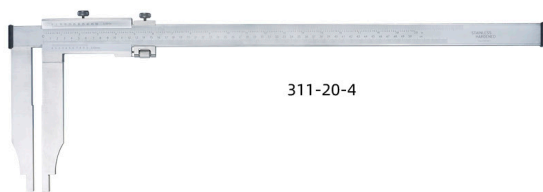

FEATURES

- Graduation:
Inch: .001" or 1/128"
Metric: 0.02mm or 0.05mm
- Stainless steel
- Models available with an assortment of metric/inch scale configurations
- Designed with fine adjustment to allow precise movement of the slider
- Internal measurement jaws are rounded to provide accurate measurement of internal diameters

Mono Block Models

Lower Range	Upper Range	Lower Graduation	Upper Graduation	Accuracy	Code No.
0-300mm	0-12"	0.02mm	.001"	±0.04mm	311-12-4
0-500mm	0-20"	0.02mm	.001"	±0.05mm	311-20-4
0-750mm	0-30"	0.02mm	.001"	±0.07mm	311-30-4
0-500mm	0-20"	0.05mm	1/128"	±0.08mm	311-20-6

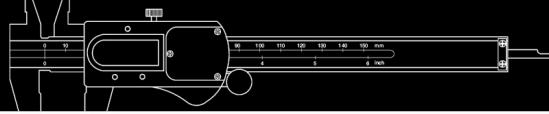

Dial Calipers

303/304 Series

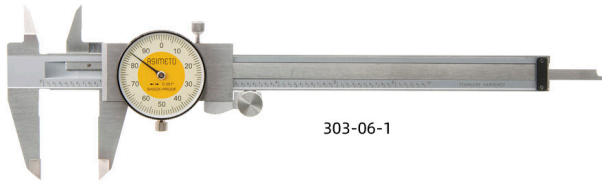

303-06-1

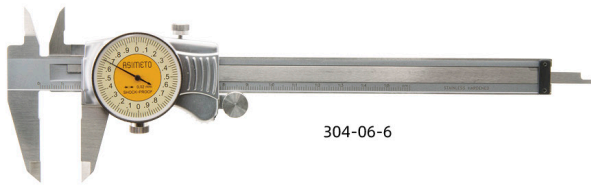

304-06-6

FEATURES

- Graduation: .001" / 0.01mm or 0.02mm
 - Stainless steel construction with all measuring surfaces surface-hardened
 - Preloaded dual pinions eliminate backlash and provide better repeatability
 - Thumb wheel included
- Aluminum models
- Sturdy Aluminum ergonomic diecast housing can be used without damage in the harshest of manufacturing environments, including situations with hot steel chips
 - The dual pinion mechanism offers extra smooth operation

Standard Models

Inch		Graduation: .001"
Range	Accuracy	Code No.
0-6"	±.001"	303-06-1
0-8"	±.0015"	303-08-1
0-12"	±.0015"	303-12-1

Aluminum Dial Housing Models

Inch		Graduation: .001"
Range	Accuracy	Code No.
0-6"	±.001"	304-06-5
0-8"	±.0015"	304-08-5
0-12"	±.0015"	304-12-5

Aluminum Dial Housing Models

Metric		Graduation: 0.02mm
Range	Accuracy	Code No.
0-150mm	±0.02mm	304-06-6
0-200mm	±0.03mm	304-08-6
0-300mm	±0.04mm	304-12-6

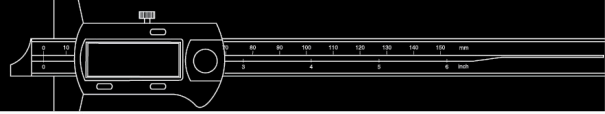

ABS Digital Calipers For Outside Grooves

309 Series

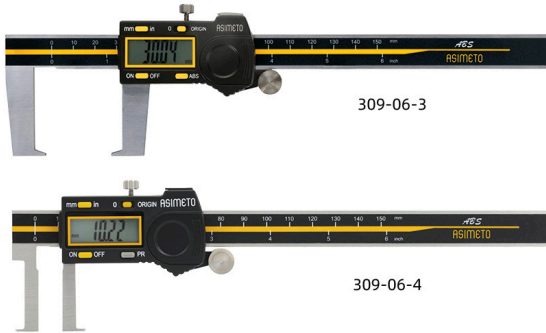

FEATURES

- Resolution: .0005"/0.01mm
- Button function: On/Off, ABS, mm/inch, Origin
- Absolute system delivers reliable measurement
- Auto-Off
- Optional accessory: Cable data output: 900-05-4/5 Bluetooth data output: 901-01-2/4 Wireless data output: Transmitting device: 901-00-4/6 Receiver device: 901-00-3



Outside Grooves

Inch		Metric		Code No.
Range	Accuracy	Range	Accuracy	
0-6"	±.001"	0-150mm	±0.03mm	309-06-3
0-8"	±.0015"	0-200mm	±0.04mm	309-08-3

Inside Grooves

Inch		Metric		Code No.
Range	Accuracy	Range	Accuracy	
0.8-6"	±.001"	20-150mm	±0.03mm	309-06-4
1-8"	±.0015"	25-200mm	±0.04mm	309-08-4
1.2-12"	±.002"	30-300mm	±0.04mm	309-12-4

IP67 Digital Depth Calipers

327 Series



FEATURES

- Resolution: .0005"/0.01mm
- Both of the measuring surfaces are precision ground for accuracy
- Button function: On/Off, Zero, mm/inch, ABS/INC, Hold
- Metal housing, strong and durable
- Hold function for easy reading
- Auto On/Off
- Protection level IP67



Inch		Metric		Dimensions							Code No.
Range	Accuracy	Range	Accuracy	L	a	c	b	d	e	f	
0-6"	±.001"	0-150mm	±0.02mm	232mm	100mm	70mm	6mm	14.5mm	7mm	10mm	327-06-9
0-8"	±.0015"	0-200mm	±0.03mm	285mm	100mm	70mm	6mm	14.5mm	7mm	10mm	327-08-9
0-12"	±.0015"	0-300mm	±0.04mm	390mm	100mm	70mm	6mm	14.5mm	7mm	10mm	327-12-9

ABS Digital Depth Calipers

327 Series



FEATURES

- Resolution: .0005"/0.01mm
- Both of the measuring surfaces are precision ground for accuracy
- Button function: On/Off, ABS, mm/inch, Origin
- Absolute system delivers reliable measurement
- Auto-Off
- Optional accessory: Cable data output: 900-05-4/5 Bluetooth data output: 901-01-2/4 Wireless data output: Transmitting device: 901-00-4/6 Receiver device: 901-00-3



Inch		Metric					Code No.
Range	Graduation	Accuracy	Range	Graduation	Accuracy		
0-6"	.0005"	±.001"	0-150mm	0.01mm	±0.03mm	327-06-7	
0-8"	.0005"	±.0015"	0-200mm	0.01mm	±0.03mm	327-08-7	
0-12"	.0005"	±.0015"	0-300mm	0.01mm	±0.04mm	327-12-7	

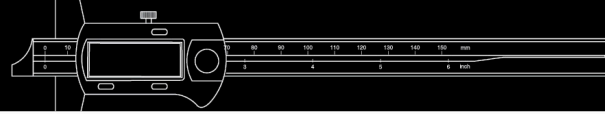

Digital Depth Calipers

327 Series

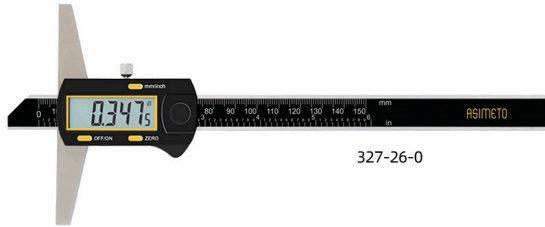

327-26-0

FEATURES

- Resolution: .0005"/0.01mm
- Both of the measuring surfaces are precision ground for accuracy
- Button function: On/Off, mm/inch, Zero

- Auto-Off



Inch			Metric			
Range	Graduation	Accuracy	Range	Graduation	Accuracy	Code No.
0-6"	.001"	±.001"	0-150mm	0.01mm	±0.03mm	327-26-0
0-8"	.001"	±.0015"	0-200mm	0.01mm	±0.03mm	327-28-0
0-12"	.001"	±.0015"	0-300mm	0.01mm	±0.04mm	327-32-0

ABS Digital Depth Calipers With Single Hook

322 Series



322-06-7

FEATURES

- Resolution: .0005"/0.01mm
- The stationary measuring surface on the beam protrudes at right angles (measuring hook) to allow for the measurement of depths, internal groove positions, and other intricate characteristics
- Measurements can be taken on either side of the measuring hook
- Button function: On/Off, ABS, mm/inch, Origin
- Absolute system delivers reliable measurement
- Auto-Off
- Optional accessory:
 - Cable data output: 900-05-4/5
 - Bluetooth data output: 901-01-2/4
 - Wireless data output:
 - Transmitting device: 901-00-4/6
 - Receiver device: 901-00-3



Inch			Metric			
Range	Graduation	Accuracy	Range	Graduation	Accuracy	Code No.
0-6"	.0005"	±.001"	0-150mm	0.01mm	±0.03mm	322-06-7
0-8"	.0005"	±.0015"	0-200mm	0.01mm	±0.03mm	322-08-7
0-12"	.0005"	±.0015"	0-300mm	0.01mm	±0.04mm	322-12-7

Digital Depth Calipers With Single Hook

322 Series

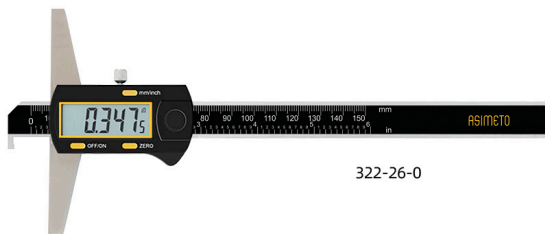

322-26-0

FEATURES

- Resolution: .0005"/0.01mm
- The stationary measuring surface on the beam protrudes at right angles (measuring hook) to allow for the measurement of depths, internal groove positions, and other intricate characteristics
- Button function: On/Off, mm/inch, Zero
- Auto-Off



Inch			Metric			
Range	Graduation	Accuracy	Range	Graduation	Accuracy	Code No.
0-6"	.001"	±.001"	0-150mm	0.01mm	±0.03mm	322-26-0
0-8"	.001"	±.0015"	0-200mm	0.01mm	±0.03mm	322-28-0
0-12"	.001"	±.0015"	0-300mm	0.01mm	±0.04mm	322-32-0

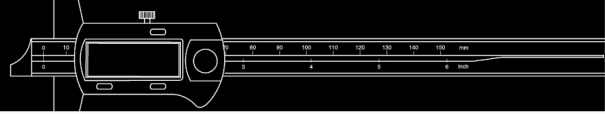

ABS Digital Depth Calipers With Double Hook

323 Series



323-06-7

FEATURES

- Resolution: .0005"/0.01mm
- The hooked measuring surfaces are used for measurement of internal or external grooves and other intricate work piece characteristics
- The base and measuring faces are hardened and precision ground
- Button function: On/Off, ABS, mm/inch, Origin
- Absolute system delivers reliable measurement
- Auto-Off
- Optional accessory:
Cable data output: 900-05-4/5
Bluetooth data output: 901-01-2/4
Wireless data output:
Transmitting device: 901-00-4/6
Receiver device: 901-00-3



Inch			Metric			
Range	Graduation	Accuracy	Range	Graduation	Accuracy	Code No.
0-6"	.0005"	±.001"	0-150mm	0.01mm	±0.03mm	323-06-7
0-8"	.0005"	±.0015"	0-200mm	0.01mm	±0.03mm	323-08-7
0-12"	.0005"	±.0015"	0-300mm	0.01mm	±0.04mm	323-12-7

Digital Depth Calipers With Double Hook

323 Series

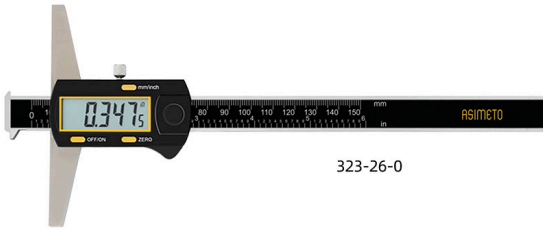

323-26-0

FEATURES

- Resolution: .0005"/0.01mm
- The hooked measuring surfaces are used for measurement of internal or external grooves and other intricate work piece characteristics
- Button function: On/Off, mm/inch, Zero
- Auto-Off



Inch			Metric			
Range	Graduation	Accuracy	Range	Graduation	Accuracy	Code No.
0-6"	.001"	±.001"	0-150mm	0.01mm	±0.03mm	323-26-0
0-8"	.001"	±.0015"	0-200mm	0.01mm	±0.03mm	323-28-0
0-12"	.001"	±.0015"	0-300mm	0.01mm	±0.04mm	323-32-0

Vernier Depth Calipers

321 Series

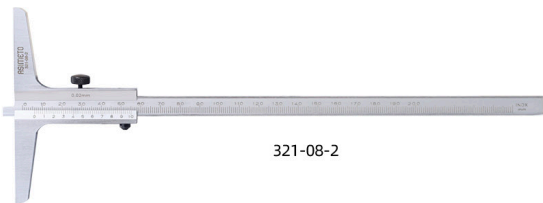

321-08-2

FEATURES

- Graduation:
Inch: .001"
Metric: 0.02mm or 0.05mm
- Both of the measuring surfaces are precision ground for accuracy

Metric			
Range	Graduation	Accuracy	Code No.
0-150mm	0.02mm	±0.03mm	321-06-2
0-200mm	0.02mm	±0.03mm	321-08-2
0-300mm	0.02mm	±0.04mm	321-12-2
0-150mm	0.05mm	±0.05mm	321-06-0
0-200mm	0.05mm	±0.05mm	321-08-0
0-300mm	0.05mm	±0.05mm	321-12-0

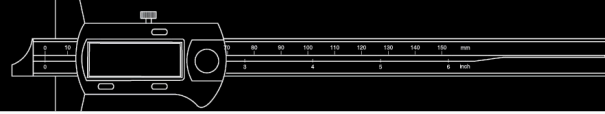

Digital Depth Gauges

475 Series



475-04-4

FEATURES

- Resolution:
Inch: .0005" or .00005"
Metric: 0.01mm or 0.001mm
- Button function: On/Off, mm/inch, Zero, Ran, Tol
- The total measuring range is accomplished with threaded depth rods in 10mm intervals
- The base surface is precisely finished and hardened for accurate repeatable measurements
- Optional accessory:
Cable data output: 900-20-0



Inch			Metric						
Range	Resolution	Accuracy	Range	Resolution	Accuracy	Stroke	Rods	Base Length	Code No.
0-4"	.0005"	.001"	0-100mm	0.01mm	0.02mm	12.7mm	10 pcs	101.5 x 17mm	475-04-2
0-4"	.00005"	.0005"	0-100mm	0.001mm	0.01mm	12.7mm	10 pcs	63 x 17mm	475-04-4

Depth Gauges

473 Series



473-04-0

FEATURES

- Graduation:
Inch: .001"
Metric: 0.01mm
- The total measuring range is accomplished with threaded depth rods in 1" or 10mm intervals
- The base surface is precisely finished and hardened for accurate repeatable measurements

							Inch
Range	Resolution	Accuracy	Stroke	Rods	Base Length	Code No.	
0-4"	.001"	±.002"	1"	4 pcs	4" x .63"	473-04-3	

							Metric
Range	Resolution	Accuracy	Stroke	Rods	Base Length	Code No.	
0-100mm	0.01mm	0.02mm	10mm	10 pcs	63 x 17mm	473-04-0	

Thickness Gauges

491 Series

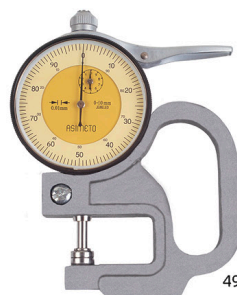

491-01-0

FEATURES

- Graduation:
Inch: .001"
Metric: 0.01mm
- Design for thickness measurement of paper, film, wire, sheet metal, jewelry, leather and similar materials, etc.
- Flat anvils

Dial Models				
Range	Graduation	Accuracy	Deep Throat	Code No.
0-.4"	.001"	±.001"	1.18"	491-01-1
0-10mm	0.01mm	±0.015mm	30mm	491-01-0

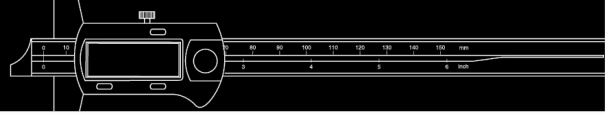

Double Beam Digital Height Gauges

627 Series



627-12-6

FEATURES

- Resolution: .0005"/0.01mm
- Large LCD display
- Button function: On/Off, mm/inch, Zero, Hold, Preset, INC, ABS, Data transfer
- Auto-Off
- High precision, measurement more accurate
- Designed with hand wheel micro-adjustable rack and pinion for precision positioning
- Can be used with a test indicator and holder for precise measurement
- External digital data input function, no need to repeat dial "0" to achieve rapid detection
- Built in bluetooth data transmission



Inch		Metric		Data Output Type	Code No.
Range	Accuracy	Range	Accuracy		
0-12"	±.001"	0-300mm	±0.02mm	Bluetooth	627-12-6
0-18"	±.0015"	0-450mm	±0.03mm	Bluetooth	627-18-6
0-24"	±.0015"	0-600mm	±0.03mm	Bluetooth	627-24-6

Digital Height Gauges

625 Series



625-24-0

FEATURES

- Resolution: .0005"/0.01mm
- Button function: On/Off, mm/inch, Zero, Hold, Set, ABS
- Auto-Off
- Can be used with a test indicator and holder for precise measurement
- The fine adjustment allows the slider to be precisely positioned
- The base is designed with a thermal heat isolation hand grip



Inch		Metric		Code No.
Range	Accuracy	Range	Accuracy	
0-12"	±.0015"	0-300mm	±0.04mm	625-12-0
0-24"	±.0020"	0-600mm	±0.05mm	625-24-0

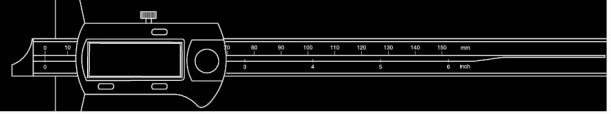

Single Beam Digital Height Gauges With Hand Wheel

626 Series



626-12-0

FEATURES

- Resolution: .0005"/0.01mm
- Button function: On/Off, mm/inch, Zero, Add+, Sub-
- Auto-Off
- Hand wheel designed for fine adjustment
- Carbide tipped scriber provided



Inch		Metric		
Range	Accuracy	Range	Accuracy	Code No.
0-12"	±.0015"	0-300mm	±0.04mm	626-12-0
0-18"	±.0015"	0-450mm	±0.04mm	626-18-0
0-24"	±.0020"	0-600mm	±0.05mm	626-24-0

Double Beam Digit Counter Height Gauges

623 Series



623-12-0

FEATURES

- Graduation:
 - Inch: .001"
 - Metric: 0.01mm
- Position is displayed by a combination of the digit counter and the dial
- Hand wheel design for both coarse and fine adjustments
- Digit counter graduation: Inch .1"/Metric 1mm
- The digit counters provide bi-directional positioning and the capability of setting zero at any position

Inch		Metric			
Range	Accuracy	Code No.	Range	Accuracy	Code No.
0-12"	±.0015"	623-12-1	0-300mm	±0.04mm	623-12-0

Vernier Height Gauges

621 Series



621-12-0

FEATURES

- Graduation:
 - Inch: .001" or 1/128"
 - Metric: 0.02mm or 0.05mm
- The fine-adjustment allows the slider to be precisely positioned
- Matte chrome finish
- Stainless steel design
- The base is designed with a thermal heat isolation hand grip

Inch			Metric			
Range	Graduation	Accuracy	Range	Graduation	Accuracy	Code No.
0-12"	1/128"	±.0015"	0-300mm	0.05mm	±0.05mm	621-12-0
0-24"	1/128"	±.0020"	0-600mm	0.05mm	±0.10mm	621-24-0
0-12"	.001"	±.0015"	0-300mm	0.02mm	±0.04mm	621-12-2
0-24"	.001"	±.0020"	0-600mm	0.02mm	±0.07mm	621-24-2



IP65 Digital Indicators

407 Series



407-01-4

FEATURES

- Resolution:
Inch: .0005"; .00005"
Metric: 0.01mm; 0.001mm
- Absolute measurement
- Button function: On/Off, mm/inch, ABS/INC, Origin, Preset, Tol +/-
- Auto-Off
- Flat back (attached) and lug back supplied Ø8mm stem diameter for metric models
- Ø3/8" stem diameter for inch models
- 330 deg. screen rotation
- Optional accessory:
Cable data output: 900-07-0/1
Bluetooth data output: 901-01-0/3
Wireless data output:
Transmitting device: 901-00-2/7
Receiver Device: 901-00-3



Inch			Metric			Inch		Metric	
Range	Resolution	Accuracy	Range	Resolution	Accuracy	Code No.	Code No.		
0-.5"	.0005"	±.0015"	0-12.7mm	0.01mm	0.02mm	407-01-3	407-01-2		
0-1"	.0005"	±.0015"	0-25.4mm	0.01mm	0.02mm	407-02-3	407-02-2		
0-2"	.0005"	±.0015"	0-50.8mm	0.01mm	0.02mm	407-03-3	407-03-2		
-	-	-	0-12.7mm	0.001mm	0.004mm	-	407-01-4		
-	-	-	0-25.4mm	0.001mm	0.005mm	-	407-02-4		
-	-	-	0-50.8mm	0.001mm	0.006mm	-	407-03-4		

IP67 Digital Indicators

408 Series



408-01-7

FEATURES

- Resolution: .00005"/0.001mm
- Inductive measurement system
- Button function: On/Off, mm/inch, ABS, Zero, Preset, Tol +/-
- With preset value function, the initial value can be set arbitrarily
- Tolerance measurement feature allows for the upper and lower tolerance for maximum and minimum
- Built in wireless transmission (optional)
- Auto-Off
- Protection level IP67
- Optional accessory:
Cable data output: 900-05-4/5
Bluetooth data output: 901-01-2/4
Wireless data output:
Transmitting device: 901-00-4/6
Receiver Device: 901-00-3



Metric				
Range	Accuracy	Resolution	Data Output Type	Code No.
0-12.7mm	0.007mm	0.001mm	SPC	408-01-6
0-25.4mm	0.008mm	0.001mm	SPC	408-02-6
0-50.8mm	0.010mm	0.001mm	SPC	408-03-6
0-101.6mm	0.015mm	0.001mm	SPC	408-04-6
0-12.7mm	0.007mm	0.001mm	Bluetooth	408-01-8
0-25.4mm	0.008mm	0.001mm	Bluetooth	408-02-8
0-50.8mm	0.010mm	0.001mm	Bluetooth	408-03-8
0-101.6mm	0.015mm	0.001mm	Bluetooth	408-04-8



Digital Indicators

405 Series



405-95-1

FEATURES

- Resolution:
Inch: .0005"; .00005"
Metric: 0.01mm; 0.001mm
- Button function: On/Off, mm/inch, Zero, Preset, ABS/INC, tol, ran
- The maximum, minimum, or runout value can be displayed during measurement.
- Tolerance measurement feature allows for the upper and lower tolerance for maximum and minimum.
- Flat back (attached) and lug back supplied
- Optional accessory: Cable data output: 900-20-0



Inch			Metric			Inch		Metric	
Range	Resolution	Accuracy	Range	Resolution	Accuracy	Code No.	Code No.		
0-.5"	.0005"	±.0015"	0-12.7mm	0.01mm	0.02mm	405-95-1	405-95-0		
0-1"	.0005"	±.0015"	0-25.4mm	0.01mm	0.02mm	405-01-1	405-01-0		
0-2"	.0005"	±.0015"	0-50.8mm	0.01mm	0.02mm	405-02-1	405-02-0		
-	-	-	0-12.7mm	0.001mm	0.004mm	-	405-95-4		
0-1"	.00005"	±.00015"	0-25.4mm	0.001mm	0.005mm	405-01-5	405-01-4		
-	-	-	0-50.8mm	0.001mm	0.006mm	-	405-02-4		

Dial Comparators

422 Series



422-21-2

FEATURES

- Resolution: 0.001mm
- High accuracy
- Jeweled and shock proof
- Water and dust resistant design

G Series					
Range	Resolution	Dial Reading	Accuracy	D	Code No.
±.002"	.00005"	.002 - 0 - .002	±.00006"	3/8"	422-21-1
±0.05mm	0.001mm	50-0-50	0.0012mm	8mm	422-21-2

Dial Indicators - One Revolution For Error-free Reading

422 Series

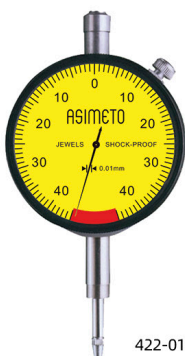

422-01-0

FEATURES

- Graduation: 0.01mm
- AGD2 series, dial face dia. Ø58mm
- Easy to read dial face
- A pair of limit hands are provided for quick and easy tolerance judgment
- Provided with an improved resistance to shop floor contaminants such as water and dust
- With flat back
- With Ø8mm stem diameter

Range	Graduation	Dial Reading	Accuracy	Code No.
±0.4mm	0.01mm	40-0-40	0.009mm	422-01-0
G Series				
±0.08mm	0.001mm	90-0-90	0.009mm	422-02-1
±0.2mm	0.005mm	20-0-20	0.009mm	422-03-1

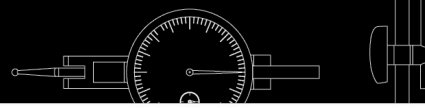

AGD1 Dial Indicators

401 Series



401-06-1

FEATURES

- Graduation:
Inch: .0005"/.001"
Metric: 0.01mm
- Dial face dia.: Ø1.61"/Ø42mm
- Jeweled
- Flat back (attached) and lug back supplied
- Inch models without revolution counter

Range	Graduation	Range/Rev.	Dial Reading	Accuracy	Code No.
Stem Diameter Ø3/8"					
0-.25"	.001"	.1"	0-100	±.001"	401-06-1
Stem Diameter Ø8mm					
0-5mm	0.01mm	0.5mm	0-50	0.012mm	401-05-0

AGD2 Dial Indicators

402 Series



402-10-0

FEATURES

- Graduation: 0.01mm
- Easy to read dial face
- Jeweled
- Internal tolerance marker
- Flat back (attached) and lug back supplied
- With counter pointer

Range	Graduation	Range/Rev.	Dial Reading	Accuracy	Code No.
Stem Diameter Ø3/8"					
0-.05"	.0001"	.01"	0-100	±.0001"	402-01-1
0-.05"	.0001"	.01"	0-50-0	±.0001"	402-01-3
0-.25"	.001"	.1"	0-100	±.002"	402-06-1
0-.50"	.001"	.1"	0-100	±.002"	402-12-1
0-1"	.001"	.1"	0-100	±.002"	402-26-1
0-1"	.001"	.1"	0-50-0	±.002"	402-26-3
0-2"	.001"	.1"	0-100	±.004"	402-51-1
Stem Diameter Ø8mm					
0-1mm	0.001mm	0.2mm	0-200	0.005mm	402-01-0
0-1mm	0.001mm	0.2mm	0-100-0	0.005mm	402-01-2
0-3mm	0.01mm	1mm	0-100	0.010mm	402-03-0
0-5mm	0.01mm	1mm	0-100	0.012mm	402-05-0
0-10mm	0.01mm	1mm	0-100	0.015mm	402-10-0
0-25mm	0.01mm	1mm	0-50-0	0.035mm	402-25-0
0-30mm	0.01mm	1mm	0-100	0.035mm	402-30-0



Dial Test Indicators

501/502/511/512 Series



Horizontal 501-78-3



Vertical 501-78-5

FEATURES

- Graduation:
Inch: .0001"; .0005",
Metric: 0.002mm; 0.01mm
- Jeweled bearings
- Inch unit comes with Ø3/8" dovetail stems
- Metric unit comes with Ø8mm dovetail stems
- Easy to read yellow face
- Horizontal models and Vertical models are available
- Ruby contact point
- 501-02-1 is with copper body

					Ø32mm / Ø1.26" Dia.		Ø32mm / Ø1.26" Dia.
Range	Resolution	Dial Reading	Accuracy	Note	Code No.	Set Code No.	Code No.
Inch							
.008"	.0001"	0-4-0	±.0001"	Horizontal	501-78-3	501-78-7	-
.03"	.0005"	0-15-0	±.0005"	Horizontal	501-73-3	501-73-8	-
.03"	.0005"	0-15-0	±.0005"	Vertical	501-73-5	-	-
Metric							
0.2mm	0.002mm	0-100-0	0.004mm	Horizontal	501-02-1	-	-
0.2mm	0.002mm	0-100-0	0.004mm	Horizontal	501-02-2	-	502-02-2
0.8mm	0.01mm	0-40-0	0.013mm	Horizontal	501-08-2	-	502-08-2
0.8mm	0.01mm	0-40-0	0.013mm	Vertical	-	-	502-08-4
1.0mm	0.01mm	0-50-0	0.013mm	Horizontal	501-10-2	-	502-10-2
G Series							
0.2mm	0.002mm	0-100-0	0.004mm	Horizontal	501-02-6	-	502-02-6
0.8mm	0.01mm	0-40-0	0.008mm	Horizontal	501-08-6	-	502-08-6
IP53 Model							
0.2mm	0.002mm	0-100-0	0.004mm	Horizontal	511-02-6	-	512-02-6
0.8mm	0.01mm	0-40-0	0.013mm	Horizontal	511-08-6	-	512-08-6

Extended Range Dial Test Indicators

503/504 Series



503-06-1



504-56-3

FEATURES

- Graduation:
Inch: .0005"/.001"
Metric: 0.01mm
- Jeweled bearing design and resistant to magnetic fields
- Stem diameter: Inch: 5/32",
Metric: 4mm
- Ruby contact point swivel 210 degrees
- Horizontal and vertical models are available
- 30 and 38mm dial diameters are available

					Ø32mm / Ø1.26" Dia.		Ø32mm / Ø1.26" Dia.
Range	Resolution	Dial Reading	Accuracy	Note	Code No.	Code No.	Code No.
Inch							
.060"	.0005"	0-15-0	±.0012"	Horizontal	503-56-1	504-56-1	504-56-1
.03"	.0005"	0-15-0	±.0005"	Horizontal	503-56-3	504-56-3	504-56-3
Metric							
0.2mm	0.002mm	0-100-0	0.004mm	Horizontal	503-56-0	504-56-0	504-56-0



Extended Range Dial Test Indicator Sets

504 Series

SET#1



504-81-1

FEATURES

- Double the range of the most of indicators
- Jeweled movement and easy to read dial
- Range: 0 - .060"
- Two dovetail stems and 3 contact points included:
Stems: 3/8" & 5/32",
Points: .04" (hardened steel), .08",
.12" (tungsten carbide) x 5/8" long

Set				
Range	Graduation	Dial Dia.	Accuracy	Set Code No.
.060"	.0005"	1.5"	±0.0012"	504-81-1
.060"	.0005"	1.0"	±0.0012"	504-81-3

Centering Indicators

469 Series



469-00-6

FEATURES

- Graduation: .0005"/0.01mm
- Provides a simplified method of centering a work piece or fixture on horizontal for vertical machines, internal or external diameters. Face of indicator remains stationary in any desired position while the machine spindle rotates, leaving the operator with both hands free to accurately position the machine table
- Shank Dia.: Ø3/8" / Ø10mm
- Operating speed not to exceed 800 RPM
- Range:
Internal: 5/32" - 12"/4 - 300mm
External: up to 12"/300mm

Code No.	Dial Range	Accuracy	Code No.
Metric	0.01mm	0.005mm	469-00-6
Inch	0.0015"	±.0002"	469-00-8



Dial Bore Gauges

483/484 Series



483-22-0

FEATURES

- Moveable probe pin with carbide ball
- .24-.4"/6-10mm range is with fixed anvils
- .4-.74"/10-18mm range is with plate guide and fixed anvils
- .7-1.4"/18-35mm range is with canister and fixed anvils
- Over 1.4"/35mm range is with wheel guide and inserting anvils

Range	Graduation	Dial Travel	Accuracy	Number Of Anvils	Number Of Spacers	Number Of Sub-anvils	Probe Depth	Code No.
Inch								
.7-1.5"	.0001"	.05" (AGD2)	±.0001"	11	2	-	6"	483-21-1
2-6"	.0001"	.05"(AGD2)	±.0005"	11	4	1	6"	483-31-1
Metric								
10-18mm	0.001mm	1mm (AGD2)	0.007mm	9	1	-	100mm	483-12-0
18-35mm	0.001mm	1mm (AGD2)	0.007mm	9	2	-	150mm	483-21-0
35-50mm	0.001mm	1mm (AGD2)	0.007mm	4	4	-	150mm	483-22-0
50-160mm	0.001mm	1mm (AGD2)	0.007mm	12	4	1	150mm	483-31-0
160-250mm	0.001mm	1mm (AGD2)	0.007mm	5	5	1	400mm	483-32-0
6-10mm	0.01mm	3mm (AGD1)	0.015mm	9	-	-	40mm	484-11-0
10-18mm	0.01mm	3mm (AGD1)	0.015mm	9	1	-	100mm	484-12-0
18-35mm	0.01mm	3mm (AGD2)	0.020mm	9	2	-	150mm	484-21-0
35-50mm	0.01mm	3mm (AGD2)	0.020mm	4	4	-	150mm	484-22-0
50-160mm	0.01mm	3mm (AGD2)	0.025mm	12	4	1	150mm	484-31-0
160-250mm	0.01mm	3mm (AGD2)	0.025mm	5	5	1	400mm	484-32-0
250-400mm	0.01mm	3mm (AGD2)	0.025mm	5	5	2	400mm	484-33-0

Tool Kits

960 Series



960-14-1B



960-14-1B

Kit #14B Digital Plus

Individual Description		Code No.	Individual Code No.
Articulating Arm With Magnetic Base, Type II	Inch	960-14-1B	602-02-1
0-.03" x .0005" Horiz. Dial Test Indicator.			501-73-3
0-1" x .001" Outside Mic.			101-01-1
0-1" x .00005" Digital Outside Mic.			105-01-5
0-.5" x .0005" AGD2 Dial Indicator			402-12-1
0-.5" x .0005" Digital Indicators			407-01-3
0-6" x .0005" ABS Digital Caliper			307-56-3
0-6" x .0005" Dial Caliper			304-06-5
Articulating Arm With Magnetic Base, Type II	Metric	960-14-0B	602-02-1
0-0.8mm x 0.01mm Horiz. Dial Test Indicator.			501-08-2
0-25mm x 0.01mm Outside Mic.			101-01-0
0-25mm x 0.001mm Digital Outside Mic.			105-01-4
0-10mm x 0.01mm AGD2 Dial Indicator			402-10-0
0-12.5mm x 0.01mm Digital Indicators			407-01-2
0-150mm x 0.01mm ABS Digital Caliper			307-56-3
0-150mm x 0.01mm Dial Caliper			P303-06-0

Magnetic Bases

601 Series



FEATURES

- Accepts test indicators with dovetail clamping mechanism
- Dial gauges can be held by the 3/8" or 8mm diameter stem or by the lug backing plate
- The rotary knob switches magnet on or off
- The precision surfaces and the bottom V are securely fastened to the ferrous work piece or machine table when the rotary knob is in the on position
- #601-02-0/1 with fine adjustment

Dimensions							Inch	Metric	
Magnetic Power	Magnetic Base	Main Stem		Sub Pole		Dia. Of Hole	Remark	Code No.	Code No.
	(L X W X H)	D1	L1	D2	L2				
80 kgf	60 x 50 x 55mm	Ø12mm	176mm	Ø10mm	165mm	Ø3/8"/Ø8mm	-	601-01-1	601-01-0
80 kgf	60 x 50 x 55mm	Ø12mm	176mm	Ø10mm	150mm	Ø3/8"/Ø8mm	Fine Adjustment	601-02-1	601-02-0

Articulating Arm Magnetic Bases

602 Series



FEATURES

- Accepts test indicators with dovetail clamping mechanism
- Dial gauges can be held by the 3/8" or 8mm diameter stem or by the lug backing plate
- Arm has 3 articulating joints that can be locked with the single hand knob
- The rotary knob switches natural magnet on or off
- The precision surfaces and the bottom V are securely fastened to the ferrous work piece or machine table when the rotary knob is in the on position

Magnetic Power	Magnetic Base	Arm	Height	Dia. Of Hole	Fine Adjustment	Code No.
	(L X W X H)	L1	L			
30 kgf	35 x 30 x 35mm	75mm	205mm	Ø3/8"/Ø8mm	With	602-01-1
80 kgf	60 x 50 x 55mm	124mm	310mm	Ø3/8"/Ø8mm	With	602-02-1
80 kgf	60 x 50 x 55mm	170mm	385mm	Ø3/8"/Ø8mm	With	602-03-1
130 kgf	117 x 50 x 55mm	325mm	635mm	Ø3/8"/Ø8mm	With	602-05-1

Universal Bevel Protractors

490 Series



490-06-5

FEATURES

- Dial Graduation: 1°, Vernier: 5'
- Designed to provide precise angular measurements
- Magnifying glass is provided for easier reading
- Can be used with a standard height gauge to provide angular measurement from reference plate
- Accuracy: ±5 min

Description	Code No.
With Three Blades: 150mm / 6", 200mm / 8", 300mm / 12"	490-06-5

Dial Protractors

490 Series



490-10-2

FEATURES

- Measuring Range: 0-360°, Graduation: 5'
- Designed with analog readout and fine adjustment to provide precise angular measurements
- Can be used with a standard height gauge to provide angular measurement from reference plate
- Accuracy: ±5 min

Description	Code No.
With Three Blades: 150mm / 6", 200mm / 8", 300mm / 12"	490-10-2

Digital Protractors

490 Series



490-15-2

FEATURES

- Resolution: 10"
- Button function: On/Off, mm/inch, Zero, Set
- Measuring Range: 0-360°
- Range selection: 1 x 360°, 2 x 180°, 4 x 90°
- Dual reading LCD display arc minutes/ decimal degrees
- With fine adjustment
- Preset function
- Accuracy: ±5 min
- Optional accessory: Cable data output: 900-20-0



Blades Included	Code No.
With Two Blades: 150mm / 6", 300mm / 12"	490-15-2

Combination Square Sets

490 Series

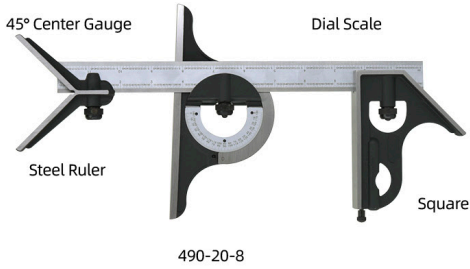

FEATURES

- Center head (made of cast iron): To locate center of cylinder with diameter (d): 1.181" DIA-3.937" DIA , accuracy: $\pm 0.006"$
- Protractor head (made of cast iron): set the blade at desired angle to an edge of a workpiece, and can be used to measure angles range: 0-180°, accuracy: $\pm 20\text{min.}$
- Square head (made of cast iron): set the blade at 90° or 45° to an edge of a workpiece, accuracy: $\pm 8\text{min}$ for 90° square, $\pm 10\text{min}$ for 45° square
- Blades are hardened and tempered for durability
- Square head has level and pointed attachment for hand scribing
- Micro-fine blade graduations
- Gauge heads are hardened cast finished in baked enamel with exception of the measurement faces

Description	Blade Length	Code No.
4 pcs Set	12"/300mm	490-20-8
4 pcs Set (With 4R Ruler)	12"/300mm	490-21-8
4 pcs Set (With 16R Ruler)	12"/300mm	490-22-8

Bevel Edge Squares

639 Series



FEATURES

- Made of precision ground hardened Stainless Steel
- Accuracy according to DIN875

DIN 875 Grade 00			
Inch Size(LxW)	Metric Size(LxW)	Angle Tolerance	Code No.
4" x 2.75"	100 x 70mm	0.003mm	639-23-0
6" x 4"	150 x 100mm	0.004mm	639-24-0
8" x 5"	200 x 130mm	0.004mm	639-25-0
12" x 8"	300 x 200mm	0.005mm	639-27-0

Precision Levels

606 Series



FEATURES

- All measuring surfaces of the square models are precision ground to facilitate readings at both horizontal and vertical planes



Range	Sensitivity	Code No.
Straight Models		
200 x 47mm	0.02mm/m	606-51-4
Square Models		
200 x 200 x 40mm	0.02mm/m	606-53-2

Digital Protractors - Level Type

490 Series



490-16-0

FEATURES

- This protractor provides an immediate digital reading of any angle in a full circle with 0° -90° -0° -90° -0° readings.
- Aluminum frame provides rigidity and light weight with a precise platform; allows the sensor and its microprocessor circuit to provide high accuracy throughout the entire 360° range
- Button function: On/Off, Zero, Hold
- Four 90° quadrants for display purposes
- Calibrates in minutes without any special fixtures
- HOLD button for freezing a reading in an unreadable position
- ABS/ZERO button allows 2 measuring modes, Standard and Alternate Reference
- V-grooves on top and bottom for use on curved surfaces
- Angle displayed upright regardless of protractor position
- Item #490-16-2 comes with magnet on base, which is helpful for fixing



Range	Resolution	Operating Temp. Range	Power	Accuracy	Size	Weight	Code No.
360°	0.1°	23° F-122° F / -5° C-50° C	3V, Lithium Cell	±0.1°	152 x 63.8 x 60mm	343g	490-16-0
360°	0.1°	23° F-122° F / -5° C-50° C	3V, Lithium Cell	±0.1°	152 x 63.8 x 60mm	343g	490-16-2

Surface Roughness Standards

506 Series

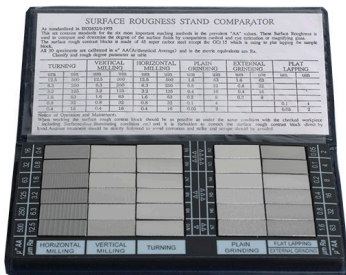

506-01-0

FEATURES

- Set of 30 specimens, 7/8" x 3/8" electro formed, solid nickel
- Used for the visual comparison of surface roughness

Code No.	506-01-0	
Qty.	Contents	Roughness
2 pcs	Flat Lapping	0.05; 0.1µm (2; 4µ")
4 pcs	Reaming	0.2; 0.4; 0.8; 1.6µm (8; 16; 32; 63µ")
6 pcs	Grinding	0.05; 0.1; 0.2; 0.4; 0.8; 1.6µm (2; 4; 8; 16; 32; 63µ")
6 pcs	Horizontal Milling	0.4; 0.8; 1.6; 3.2; 6.3; 12.5µm (16; 32; 63; 125; 250; 500µ")
6 pcs	Vertical Milling	0.4; 0.8; 1.6; 3.2; 6.3; 12.5µm (16; 32; 63; 125; 250; 500µ")
6 pcs	Turning	0.4; 0.8; 1.6; 3.2; 6.3; 12.5µm (16; 32; 63; 125; 250; 500µ")

Rectangular Steel Gauge Block Sets

650 Series



650-11-1

FEATURES

- Individual serial numbers on each block, regardless of grade
- A complete certificate of calibration traceable to the NIST or DIN showing the deviation of each block
- Mirror polished surfaces provide superior wringing characteristics

Metric			
Blocks Per Set	Blocks Included In Set	Grade	Code No.
103	1 Block: 1.005mm 49 Blocks: 1.01-1.49mm x 0.01mm Step 49 Blocks: 0.5-24.5mm x 0.5mm Step 4 Blocks: 25-100mm x 25mm Step	1	650-12-1
87	9 Blocks: 1.001-1.009mm x 0.001mm Step 49 Blocks: 1.01-1.49mm x 0.01mm Step 19 Blocks: 0.5-9.5mm x 0.5mm Step 10 Blocks: 10-100mm x 10mm Step	1	650-13-1
47	1 Block: 1.005mm 20 Block: 1.01-1.20mm x 0.01mm Step 7 Block: 1.3-1.9mm x 0.1mm Step 9 Block: 1-9mm x 1mm Step 10 Block: 10-100mm x 10mm Step	1	650-14-1
32	1 Block: 1.005mm 9 Block: 1.01-1.09mm x 0.01mm Step 9 Block: 1.1-1.9mm x 0.1mm Step 9 Block: 1-9mm x 1mm Step 4 Block: 10mm, 20mm, 30mm, 50mm	1	650-16-1

Plug Gauges And Ring Gauges

670/675 Series



670-10-7



675-10-0

FEATURES

- Hardened steel
- Plug Gauge Accuracy according to DIN 7162/7164
- Plug Gauge Sizes according to DIN 2245
- Ring Gauge Accuracy according to DIN 2250

Plug Gauges	
Size	H7 Code No.
2mm	670-02-7
3mm	670-03-7
4mm	670-04-7
5mm	670-05-7
6mm	670-06-7
7mm	670-07-7
8mm	670-08-7
10mm	670-10-7
12mm	670-12-7
16mm	670-16-7
20mm	670-20-7
40mm	670-40-7
50mm	670-50-7

Ring Gauges	
Size	Code No.
3.0mm	675-03-0
4.0mm	675-04-0
5.0mm	675-05-0
8.0mm	675-08-0
9.0mm	675-09-0
10mm	675-10-0
12mm	675-12-0
14mm	675-14-0
15mm	675-15-0
16mm	675-16-0
18mm	675-18-0
20mm	675-20-0
-	-

Ring Gauges	
Size	Code No.
30mm	675-30-0
35mm	675-35-0
40mm	675-40-0
50mm	675-50-0
60mm	675-60-0
75mm	675-75-0
80mm	675-80-0
90mm	675-90-0
100mm	676-00-0
-	-
-	-
-	-
-	-

Thread Plug Gauges And Ring Gauges

68X Series



682-14-5



685-14-5



686-14-5

FEATURES

- ISO-Metric Thread
- Per DIN13

ISO-Metric Coarse Thread			
Size	Plug Gauge 6H	Ring Gauge "GO" 6g	Ring Gauge "NO GO" 6g
M2	680-02-0	-	-
M3	680-03-0	683-03-1	684-03-0
M4	680-04-2	683-04-1	684-04-0
M5	680-05-2	683-05-1	684-05-0
M6	680-06-2	683-06-1	684-06-0
M8	680-08-2	683-08-1	684-08-0
M10	680-10-2	683-10-1	684-10-0
M12	680-12-2	683-12-1	684-12-0
M14	680-14-2	683-14-1	684-14-0
M16	680-16-2	683-16-1	684-16-0
M18	680-18-2	683-18-1	684-18-0
M20	680-20-2	683-20-1	684-20-0
M22	680-22-2	683-22-1	684-22-0
M24	680-24-2	683-24-1	684-24-0
M27	680-27-2	683-27-1	684-27-0
M30	680-30-2	683-30-1	684-30-0
M33	680-33-2	683-33-1	684-33-0
M36	680-36-2	683-36-1	684-36-0

ISO-Metric Fine Thread			
Size	Plug Gauge 6H	Ring Gauge "GO" 6g	Ring Gauge "NO GO" 6g
M4.0 x 0.5	682-04-1	685-04-1	686-04-1
M5.0 x 0.5	682-05-1	685-05-1	686-05-1
M6.0 x 0.5	682-06-1	685-06-1	686-06-1
M8.0 x 0.5	682-08-1	685-08-1	686-08-1
M10 x 0.5	682-10-1	685-10-1	686-10-1
M12 x 0.5	682-12-1	685-12-1	686-12-1
M12 x 1.5	682-12-5	685-12-5	686-12-5
M14 x 1.5	682-14-5	685-14-5	686-14-5
M16 x 1.5	682-16-5	685-16-5	686-16-5
M18 x 1.5	682-18-5	685-18-5	686-18-5
M20 x 1.5	682-20-5	685-20-5	686-20-5
M22 x 1.5	682-22-5	685-22-5	686-22-5
M24 x 1.5	682-24-5	685-24-5	686-24-5
M25 x 1.5	682-25-5	685-25-5	686-25-5
M26 x 1.5	682-26-5	685-26-5	686-26-5
M27 x 1.5	682-27-5	685-27-5	686-27-5
M28 x 1.5	682-28-5	685-28-5	686-28-5
M30 x 1.5	682-30-5	685-30-5	686-30-5
M32 x 1.5	682-32-5	685-32-5	686-32-5
M36 x 1.5	682-36-5	685-36-5	686-36-5
M33 x 3	682-33-7	685-33-7	686-33-7
M36 x 3	682-36-7	685-36-7	686-36-7

Whitworth Pipe Thread Plug Gauges And Ring Gauges

690 Series



690-01-1



690-02-3



690-02-4

FEATURES

- Right hand, DIN ISO 228

Code No.			
Size	Plug Gauge	Ring Gauge "GO"	Ring Gauge "NO GO"
G1/16	690-01-1	-	-
G1/8	690-02-1	690-02-3	690-02-4
G1/4	690-03-1	690-03-3	690-03-4
G3/8	690-04-1	690-04-3	690-04-4
G1/2	690-05-1	690-05-3	690-05-4
G5/8	690-06-1	690-06-3	690-06-4
G3/4	690-07-1	690-07-3	690-07-4
G7/8	690-08-1	690-08-3	690-08-4
G1	690-09-1	690-09-3	690-09-4

Code No.			
Size	Plug Gauge	Ring Gauge "GO"	Ring Gauge "NO GO"
G1-1/8	690-10-1	690-10-3	690-10-4
G1-1/4	690-11-1	690-11-3	690-11-4
G1-1/2	690-12-1	690-12-3	690-12-4
G1-3/4	690-13-1	690-13-3	690-13-4
G2	690-14-1	690-14-3	690-14-4
G2-1/4	690-15-1	690-15-3	690-15-4
G2-1/2	690-16-1	690-16-3	690-16-4
G2-3/4	690-17-1	690-17-3	690-17-4
G3	690-18-1	690-18-3	690-18-4



Impact Hardness Testers

640 Series



640-17-1

FEATURES

- Large screen with color display, allows for clear display of all functions and parameters
- Hardness test can be taken at any angle including inverted
- A wide measuring range supports the hardness of all metallic materials. Hardness results are directly displayed in HRB, HRC, HV, HB, HS, HL hardness scales.
- Six impact devices are available for special application with automatic impact device recognition
- Diameter of carbide ball: 3mm
- Large capacity memory storage of 500 sub groups. Stored information including single measured value, mean value, test data, impact direction, impact times, material and hardness scale are available
- Support two languages display, English and Chinese
- Upper and lower limit can be preset. An audio alarm will automatically sound when the reading is outside of the preset limits
- Battery voltage information is displayed including the charge status
- Calibration function is available.
- USB 1.1 port allows for information to be uploaded directly to computer
- High speed thermal printer allows for the readings to be immediately printed
- 6V Ni-MH rechargeable battery are supplied. The batteries can be charged with the integrated charger. Up to 150 hours of continuous operation battery life between charges (eL off and no printing)
- Automatic power off after five minutes

Range	Accuracy	Application Range	Impact Devices	Impact Capacity	Code No.
(170-960) HLD (17-68.5) HRC (19-651) HB	HLD: ±5 HRC: ±1 HB: ±4	Test The Normal Smooth, Flat Surface	D	11 Nmm	640-17-1
		Test Hole Or Hollow Cylindrical	DC	11 Nmm	640-17-2
		Test Small, Light, Thin Parts And Surface Of Hardened Layer	C	2.7 Nmm	640-17-3
		Test Groove Or Re-Entrant Surface	D+15	11 Nmm	640-17-4
		Test Slender Narrow Groove Or Hole	DL	11 Nmm	640-17-5
		Test Large, Thick, Heavy And Rough Surface Steel	G	90 Nmm	640-17-6



Surface Roughness Testers

645 Series



645-13-0

FEATURES

- 3.5-inch color graphic touch screen, provide high brightness, wide viewing angle
- Display full information, intuitive and graphical displays all parameters
- DSP chip control and data processing, high speed, low power consumption
- 4 Profile Filter: Gauss RC PC-RC D-P
- Multi parameters: Ra, Rz, Rq, Rt, Rp, Rv, R3z, R3y, Rz (JIS), Rs, Rsk, Rsm, Rku, Rc, Ry, Rmax, Rmr, Rpc, Rk, Rpk, Rvk, Mr1, Mr2
- Complies with the following standards: ISO, DIN, ANSI, JIS
- Roughness tester can be operated by mobile phones (only Android system) or computers
- Data can be sent to Excel by connecting to computers via bluetooth or SPC cable - Support bluetooth printer
- Large capacity data storage, can store 100 item of raw data and measured profile
- With automatic sleep, automatic shutdown power saving features

Code No.	645-13-0	
Measuring Range	X Axis: 17.5mm/0.69"	
	Z Axis: 320µm (-160µm ~ 160µm)/12600µin(-6300µin ~ 6300µin)	
Resolution(Ra)	0.001µm	
Accuracy	±10%	
Probe	Type	Inductive
	Stylus Radius/Angle	5µm/90°
	Stylus Material	Diamond
Measuring Force	4mN	
Sampling Length	0.25, 0.8, 2.5mm	
Number of cut-offs	1-5	
Measuring Speed	0.135, 0.5, 1mm/s, 1mm/s (Return)	
Memory	100 measurement results	
Output	Bluetooth and USB	
Power Supply	Built-In Rechargeable Lithium Ion Battery	
Size	Control Unit: 160 x 64 x 53mm	

Standard Pack	
Main Unit	1 pc
Axe Sensor	1 pc
Calibration Block and Support	1 pc of each
Connecting cable (long and short)	1 pc of each
Adjustable Stand	1 pc
Touch pen	1 pc
USB cable	1 pc
AC/DC Adapter	1 pc

Optional Accessories	
Axe Sensor	PJ6450-02
Curved Surface Sensor	PJ6450-03
Deep Groove Sensor	PJ6450-04
Small Hole Sensor	PJ6450-05
Very Small Hole Sensor	PJ6450-15
Groove sensor	PJ6450-25
Extension Rod	PJ6450-16
Bluetooth printer	PJ6450-14



Surface Roughness Tester

645 Series



645-12-0

FEATURES

- 2.5-inch color screen, provide high brightness, wide viewing angle
- Display full information, intuitive and graphical displays all parameters
- DSP chip control and data processing, high speed, low power consumption
- 4 Profile Filter: Gauss RC PC-RC D-P
- Multi parameters: Ra, Rz, Ry, Rq, Rc, Rt, Rmax, Rp, Rv, R3z, R3y, Rz (JIS), Rs, Rsk, Rku, Rsm, Rpc, Rmr
- Complies with standards: ISO, DIN, ANSI, JIS
- Can switch the display direction, convenient for left and right hand operation
- Data can be sent to Excel by connecting to computers via bluetooth or SPC cable - support bluetooth printer
- Large capacity data storage, can store 100 item of raw data and measured profile
- With automatic sleep, automatic shutdown power saving features

Code No.	645-12-0	
Measuring Range	X Axis: 17.5mm/0.69"	
	Z Axis: 160µm /6300µin	
Resolution(Ra)	0.001µm	
Accuracy	±10%	
Probe	Type	Inductive
	Stylus Radius/Angle	5µm/90°
	Stylus Material	Diamond
Measuring Force	4mN	
Sampling Length	0.25, 0.8, 2.5mm	
Measuring Speed	0.135, 0.5, 1mm/s, 1mm/s (Return)	
Size	142 x 55 x 40mm	
Power Supply	Built-in 800mAh Rechargeable Lithium Ion Battery	

Standard Pack	
Main Unit	1 pc
Small Hole Sensor	1 pc
Calibration Block and Support	1 pc of each
Adjustable Stand	1 pc
Probe Cover	1 pc
USB Cable	1 pc
AC/DC Adapter	1 pc

Optional Accessories	
Axe Sensor	PJ6451-01
Curved Surface Sensor	PJ6451-02
Deep Groove Sensor	PJ6451-03
Small Hole Sensor	PJ6451-04
Very Small Hole Sensor	PJ6451-05
Groove sensor	PJ6451-06
Extension Rod	PJ6451-07
Bluetooth printer	PJ6450-14

Wireless Data Transmission Devices With 8 Channels

901 Series



Receiver 901-00-3

FEATURES

- High reliability
- Small size
- 15 meters valid distance
- LED or buzzer indicating
- 8 channels
- Work with Microsoft Office directly

8 Channels Wireless Transmitters And Receiver			
Function	Used For	Frequency	Code No.
Transmitter	IP65 Digital Indicators	2.4GHz	901-00-2
Receiver	ABS Digital Calipers/ABS Heavy Duty Digital Calipers/Digital Micrometers/ IP65/IP67 Digital Indicators	2.4GHz	901-00-3
Transmitter	ABS Digital Calipers/ABS Heavy Duty Digital Calipers/Digital Micrometers	2.4GHz	901-00-4
Transmitter With Footswitch Interface	ABS Digital Calipers/ABS Heavy Duty Digital Calipers/Digital Micrometers/ IP65/IP67 Digital Indicators	2.4GHz	901-00-6
Transmitter With Footswitch Interface	IP65 Digital Indicators	2.4GHz	901-00-7

Bluetooth Data Transmission Devices

901 Series



Transmitter 901-01-2 (Micro-USB)

FEATURES

- High reliability
- 10 meters valid distance, connect to the equipment with built-in Bluetooth, no additional receiving devices is needed
- Dot or comma data format are optional
- May connect foot-switch, releasing hands
- Desktop software and mobile app are both available for free
- Data transmission format can be selected*

Bluetooth Transmitters			
Function	Used For	Frequency	Code No.
Transmitter	IP65 Digital Indicators	Bluetooth	901-01-0
Transmitter	ABS Digital Calipers/ABS Heavy Duty Digital Calipers/Digital Micrometers	Bluetooth	901-01-2
Transmitter With Footswitch Interface	IP65 Digital Indicators	Bluetooth	901-01-3
Transmitter With Footswitch Interface	ABS Digital Calipers/ABS Heavy Duty Digital Calipers/Digital Micrometers	Bluetooth	901-01-4
Transmitter	IP65 Digital Micrometers	Bluetooth	901-01-5

* Keyboard format: no need specialized software, data transmitted to Office interface directly.

UUID format:

- 1) Match specialized Windows software, data transmitted to designated file, analyze data directly, User may define other data analysis file.
- 2) Match specialized mobile terminate, data can be recorded with voice, simplified data analysis chart, data exported

Data Collection Measuring Tools

900 Series

Image	Used For	Interface To PC	Data	Corresponding	Code No.
	ABS Digital Calipers Digital Micrometers Heavy Duty Digital Calipers	USB	Dot Data Format	307-XX-2 ; 307-XX-3 105-XX-4 ; 105-XX-5	900-05-4
			Comma Data Format	315-XX-6 ; 315-XX-8	900-05-5
	IP65 Digital Indicators	USB	Dot Data Format	407-XX-2 ; 407-XX-3	900-07-0
			Comma Data Format	407-XX-4 ; 407-XX-5	900-07-1
	Digital Indicators	USB	Dot Data Format	405-95-X ; 405-01-X 405-02-X ; 405-04-X	900-20-0
	Digital Micrometers	USB	Dot Data Format	Special Digital Micrometers	900-10-0
	Digital Micrometers	USB	Dot Data Format	Special Digital Micrometers	900-10-2
	Footswitch For Wireless Devices				900-90-1

Canada

500 Manitou Drive
Kitchener, Ontario N2C 1L3

Tel: +1 800 265 8221

E-mail: canadasales@asimeto.com

U.S.A.

101 - 137 Overhill Drive
 Mooresville, NC 28117

Tel: +1 800 265 8221

E-mail: usasales@asimeto.com

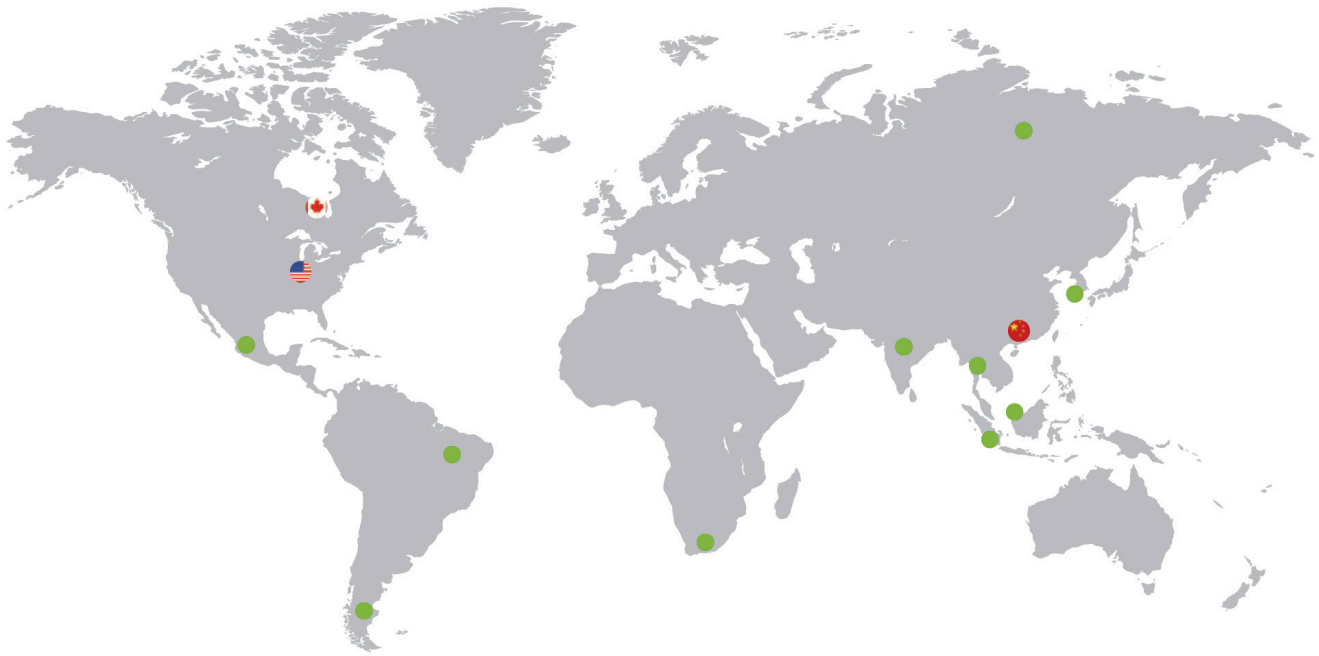

China

402, Building B,
Yushu Chuangxin Zone,
Huangpu Dist., Guangzhou

Tel: +86 020 8208 6170

E-mail: info@asimeto.com

ASIMETO

Asimeto Inc.
www.asimeto.com

